



Accident
on 24 December 2000
at Tahiti Faaa Airport
to the DC10-10
registered N132AA
operated by Hawaiian Airlines

REPORT
n-aa001224a

FOREWORD

This report presents the technical conclusions reached by the BEA on the circumstances and causes of this accident.

In accordance with Annex 13 of the Convention on International Civil Aviation, with EC directive 94/56 and with the Civil Aviation Code (Book VII), the investigation is intended neither to apportion blame, nor to assess individual or collective responsibility. The sole objective is to draw lessons from this occurrence which may help to prevent future accidents or incidents.

Consequently, the use of this report for any purpose other than for the prevention of future accidents could lead to erroneous interpretations.

SPECIAL FOREWORD TO ENGLISH EDITION

This report has been translated and published by the BEA to make its reading easier for English-speaking people. As accurate as the translation may be, the original text in French should be considered as the work of reference.

Table of Contents

FOREWORD	2
GLOSSARY	6
SYNOPSIS	7
ORGANISATION OF THE INVESTIGATION	8
1 - FACTUAL INFORMATION	9
1.1 History of Flight	9
1.2 Injuries to Persons	10
1.3 Damage to Aircraft	10
1.4 Other damage	10
1.5 Personnel information	10
1.5.1 Captain	10
1.5.2 Copilot	11
1.5.3 Flight Engineer	11
1.6 Aircraft Information	11
1.6.1 Airframe	11
1.6.2 Engines	12
1.7 Meteorological Conditions	12
1.7.1 General situation	12
1.7.2 Forecast provided to crew	13
1.7.3 Meteorological conditions at Faaa during the landing	13
1.8 Aids to Navigation	16
1.9 Telecommunications	16
1.10 Aerodrome Information	17
1.10.1 Characteristics	17
1.10.2 On-board documentation	18
1.10.3 Runway lighting	18
1.10.4 Runway surface condition	19
1.11 Flight Recorders	19
1.11.1 Types and readout operations	19
1.11.2 FDR readout	20
1.11.3 CVR	22

1.12 Wreckage and Impact Information	22
1.13 Medical and Pathological Information	23
1.14 Fire	23
1.15 Survival Aspects	24
1.16 Tests and Research	25
1.16.1 Airplane's track on the runway	25
1.16.2 Wet runway and crosswind	26
1.16.3 Examination of tires	27
1.16.4 Spoilers	27
1.16.5 Examination of life jackets	28
1.16.6 GFMS	28
1.17 Information on Organizations and Management	28
1.17.1 Flight preparation	28
1.17.2 Crosswind procedure	29
1.17.3 Crosswind and wet runway procedure	29
1.17.4 Use of flaps	30
1.17.5 Crew training	30
1.17.6 Calculation of landing and landing roll distances	30
1.18 Additional Information	31
1.18.1 Controller's testimony	31
1.18.2 Crew testimony	31
2 - ANALYSIS	33
2.1 Scenario	33
2.1.1 The approach	33
2.1.2 The flare	33
2.1.3 The landing roll	33
2.1.4 The runway excursion	34
2.1.5 The evacuation	34
2.2 Strategy for performing approaches	34
2.3 Faa runway Infrastructure	35
2.4 Documentation used by the crew	35
2.5 Flight recorders	36
3 - CONCLUSIONS	37
3.1 Findings	37
3.2 Causes of the accident	37

4 - RECOMMENDATIONS _____ **38**

LIST OF APPENDICES _____ **40**

Glossary

ACARS	ARINC Communication and Addressing Reporting System
AIP	Aeronautical Information Publication
ATIS	Automatic Terminal Information Service
CVR	Cockpit Voice Recorder
DGAC	French civil aviation directorate (Direction Générale de l'Aviation Civile)
DME	Distance Measuring Equipment
FAA	Federal Aviation Administration (USA)
FDR	Flight Data Recorder
GFMS	General Flight Management System
GPWS	Ground Proximity Warning System
IAC	Instrument Approach Chart
IAF	Initial Approach Fix
ICAO	International Civil Aviation Organisation
ILS	Instrument Landing System
LD	Landing Distance
METAR	Meteorological Aviation Report
NM	Nautical Mile
NOTAM	Notice To Airmen
NTSB	National Transport Safety Board (USA)
PAC	Pacific Region
PAPI	Precision Approach Path Indicator
PF	Pilot Flying
PNF	Pilot Not Flying
QFU	Runway orientation
QNH	Altimeter setting to obtain aerodrome elevation when on the ground
SPECI	Special meteorological observation at aerodrome
UTC	Universal Time Coordinated
VOR	Very high frequency Omnidirectional Radio range

SYNOPSIS

Date and time

24 December 2000 at 9 h 55 min⁽¹⁾

Aircraft

Mc Donnell Douglas Corp DC10-10
Registered N132AA

Site of accident

Tahiti Faaa Aerodrome
(French Polynesia)

Owner

American Airlines Inc.

Type of flight

Scheduled international flight HAL 481
Public transport of passengers

Operator

Hawaiian Airlines Inc.

Persons on board

3 flight crew
12 cabin crew
139 passengers

Summary

While landing on runway 04, in a storm, the airplane touched down about halfway down the runway. It overran the end of the runway and came to a stop resting on its engines, its nose in the lagoon.

Consequences

	Persons			Equipment	3rd Parties
	Fatalities	Injured	Unhurt		
Crew	0	0	15	Damaged	LLZ destroyed
Passengers	0	0	139		

⁽¹⁾ Except where otherwise noted, the times shown in this report are expressed in Universal Time Coordinated (UTC). Ten hours should be subtracted to obtain the time in Tahiti on the day of the accident or one hour added to obtain the applicable time in Paris on the day of the accident.

ORGANISATION OF THE INVESTIGATION

The initial work in the investigation was undertaken by a team consisting of the BEA investigator on duty at Le Bourget and the Field Investigator at Tahiti Faaa. An Investigator-in-Charge (IIC) was then nominated to take over. The NTSB was informed and invited to nominate an Accredited Representative on behalf of the USA as State of Registry and State of Manufacture of the airplane.

The Field Investigator carried out the preliminary gathering of evidence. Examination of the tires and the life jackets was performed by technicians from the airline.

The flight recorders were taken to the BEA by a judicial police officer. They were opened in his presence and the recordings were then read out, in coordination with the NTSB.

A two-man team, led by the IIC, then went to the headquarters of Hawaiian Airlines in Honolulu to collect information and to analyze parameters with the assistance of NTSB investigators and advisers from the FAA and the operator.

Calculation of the airplane's performance was performed by Hawaiian Airlines, under the supervision of the NTSB.

1 - FACTUAL INFORMATION

1.1 History of Flight

On Sunday 24 December 2000 at 4 h 38 min, the DC10 registered N132AA took off from Honolulu bound for Tahiti with a hundred and thirty-nine passengers and fifteen crew members on board. This was Hawaiian Airlines scheduled international flight HAL 481. The flight crew consisted of a Captain, a co-pilot and a flight engineer. No notable events occurred on the flight until the approach.

Between 9 h 24 min 35 s and 9 h 26 min 57 s, the Captain, Pilot Flying (PF), performed the arrival briefing and mentioned the following items: runway in service, beginning of descent, ARONA 1V approach (OVINI-VOR DME-ILS 04), documentation validity, VOR frequency, description of missed approach. He then asked the co-pilot to find out about the weather. The controller transmitted the 9 h 00 information, mentioning a 080°/5 kt wind, occasionally 340°/15 kt, with gusts to 25 kt. He also mentioned rain showers, some cumulonimbus and indicated that the runway was wet.

During the descent, numerous thunderstorm cells were observed by the crew on the track and around the aerodrome.

At 9 h 32 min 19 s, flight HAL 481 passed the ARONA point at 9,000 ft.

At 9 h 46 min 30 s, the tower controller asked them to descend towards 2,500 ft QNH and to report back when passing OVINI. He stated that there were showers at the aerodrome. Twenty-two seconds later, the co-pilot announced that they were passing OVINI.

At 9 h 49 min 04 s, the Captain armed the spoilers. At 9 h 49 min 09 s, he asked for the flaps to be extended to 22° then, twenty-five seconds later, to the 35° position.

At 9 h 49 min 46 s, the controller cleared flight HAL 481 to land on runway 04. He gave the wind as 060°/10 kt, gusting to 14. The Captain noticed changes in the wind and the co-pilot announced, based on the airplane's GFMS, a wind from 280° at 28 kt.

At 9 h 51 min 24 s, the controller transmitted new meteorological information: 330°/18 kt, gusting to 28. Thirty-two seconds later, the crew had the airfield in sight and a final wind reading was given to them: 330°/18 kt, gusting to 29.

At 9 h 52 min 11 s, the autopilot was disconnected. Nine seconds later, the airplane passed under the approach path and the GPWS "sink rate" warning sounded. The pilot rejoined the descent path with the aid of the PAPI and continued his approach using external visual references. At that time, the airplane was following a track parallel and to the right of the approach path.

Between 9 h 52 min 32 s and 9 h 52 min 38 s, the radio altimeter call-outs between fifty and ten feet began and continued at a rate of one per second. Power reduction began five seconds after the ten feet call-out.

At 9 h 52 min 45 s, the wheels of the main landing gear touched the runway, to the right of the centerline. Five seconds later, which was two seconds after the nose gear touched down, the thrust reversers were deployed. The parameters indicate that reverse thrust on each of the engines was adjusted and regulated without it ever reaching its maximum value.

At 9 h 52 min 53 s, eight seconds after the main landing gear touched down, the spoilers were deployed manually by the flight engineer.

At 9 h 52 min 59 s, the copilot's "Centerline" call-out suggested the Captain rejoin the runway centerline, from which the airplane was moving away to the left.

At 9 h 53 min 21 s, the airplane crushed the localizer antennae, continued along the runway extended centerline and then came to a stop past the end of the runway, its nose in the lagoon.

The Captain, after checking on the safety situation around the airplane, ordered the evacuation via door 2R.

1.2 Injuries to Persons

No injuries were sustained during the accident or the subsequent evacuation.

1.3 Damage to Aircraft

The airplane was damaged by contact between the main landing gear and the out-board engines with obstacles, as well as by the immersion of the forward part of the airplane.

1.4 Other damage

The localizer aeriels were completely destroyed.

1.5 Personnel information

1.5.1 Captain

Male, aged 56.

- Valid Commercial Pilot's License.
- Last medical checkup on 4 December 2000.

- Last line check or equivalent on 25 September 2000 (recurrent, simulator).
- Total flying hours: 18,905.
- Flying hours on DC10: 4,860 (all as Captain).
- Flying hours in three previous months: 214 (all on DC10).
- Type ratings DC-10, L-1011, DC-9, DHC-7.

Before joining Hawaiian Airlines in 1977, the pilot had been employed by the US Navy until 1975, by Panorama Air Tours and by Royal Hawaiian Air Service.

1.5.2 Copilot

Male, aged 35.

- Valid Commercial Pilot's License.
- Last medical checkup on 16 May 2000.
- Last line check or equivalent on 25 January 2000 (recurrent, simulator).
- Total flying hours: 7,142.
- Flying hours on DC10: 526.
- Flying hours in three previous months: 179 (of which 121 on DC10).
- Type rating: DHC-8.
- DC-10 Flight Engineer.

Before being employed by Hawaiian Airlines as a Flight Engineer from 1998, this pilot had been employed by Island Air then by the Air National Guard.

1.5.3 Flight Engineer

Male, aged 37.

- Valid Flight Engineer's License.
- Last medical checkup on 6 June 2000.
- Last line check or equivalent on 13 December 2000 (simulator).
- Total flying hours: 4,133 (of which 600 as Flight Engineer).
- Flying hours on DC10: 613 as Flight Engineer.
- Flying hours in three previous months: 259.

Before being employed in 1999 by Hawaiian Airlines, the Flight Engineer had worked for Corporate Air.

1.6 Aircraft Information

1.6.1 Airframe

- Manufacturer: MCDONNELL DOUGLAS CORP.
- Type: DC10-10.

- Serial n°: 47827.
- Airworthiness certificate issued on 9 November 1979.
- Total service time on 24 December 2000: 64,841 flying hours.
- Last overhaul: 29 November 2000.
- Flying time since last overhaul: 152 hours.

1.6.2 Engines

Manufacturer: GENERAL ELECTRIC.

Type: GE CF6-6 K.

Thrust under standard conditions: 42,000 lbs or 18,670 daN.

As of 24 December 2000			
	left	central	right
Serial number	451218	451125	451455
Total flying hours	1,469	1,469	1,469
Total flying hours since overhaul	1,469	1,469	1,469
Total flying hours since service	1,469	1,469	1,469

1.7 Meteorological Conditions

1.7.1 General situation

Surface situation:

An active convergence line was crossing the island with numerous stratocumuli and scattered squalls.

Situation at altitude:

Above the lower layer convergence, a notable altitude divergence was observed over the area, a factor that particularly amplified the instability.

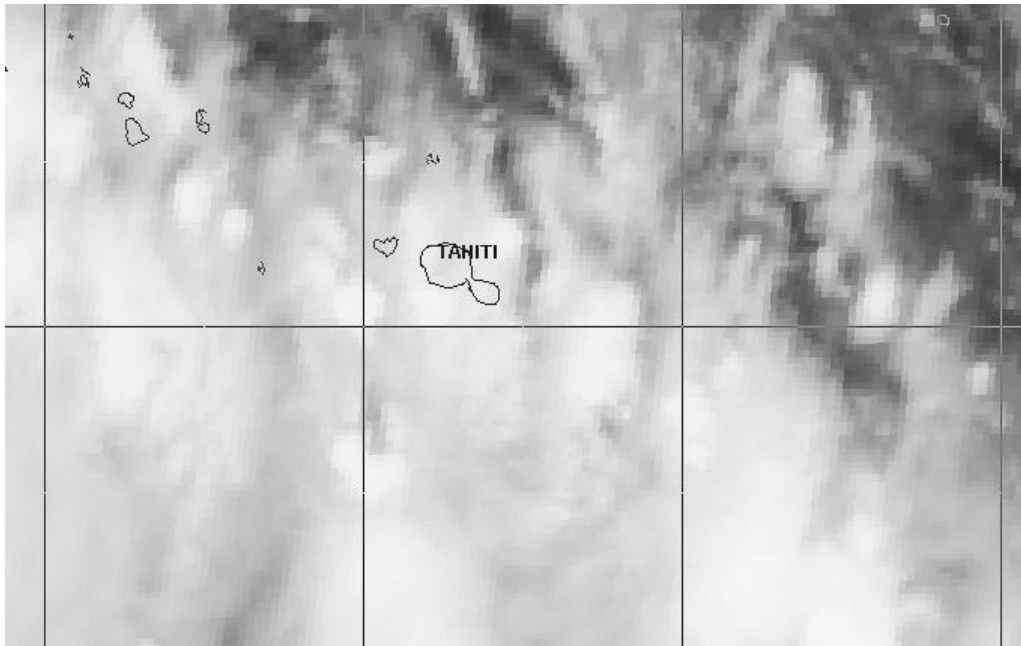

Figure 1 – Infra-red satellite photo taken by GOES 10 on 24/12/00 at 10 h 52

1.7.2 Forecast provided to crew

Forecast included in flight dossier:

PPT: 232100Z 240024 34015KT 9999 VCSH FEW010 FEW012CB BKN016
 BKN045 TEMPO 0024 34015G25KT 5000 SHRA SCT008 SCT010CB BKN015
 OVC035 PROB40 TEMPO 0024 34025G40KT 1000 ?TSRA SCT006 BKN008CB
 OVC015

ACARS update of METAR on 24 December at 4 h 00:

PPT: 240400Z 36012KT 9999 VCSH FEW008 FEW010CB SCT013 BKN040
 27/25 Q1007 TEMPO 34015G25KT 4000 SHRA SCT010CB BKN015 OVC035

ACARS update of METAR on 24 December at 9 h 00:

PPT: 240900Z 08005KT 9999 SCT015 SCT016CB BKN050 26/24 Q1009 TEMPO
 34015G25KT 4000 SHRA SCT010CB BKN015 OVC035

1.7.3 Meteorological conditions at Faa during the landing

1.7.3.1 Meteorological observations

METAR at 10 h 00:

Wind 290° / 18 kt, heading variation 240° to 360°, visibility 2,000 m, air temperature 26°C, dew point 24,3°C, 4/8 of cumulonimbus at 1,600 ft, QNH 1009, lightning notified by observer.

SPECI at 9 h 52 min:

Wind variable 08, gusts to 27 kt, direction variation 290° to 200°, visibility 2,000 m,

light rain showers, 3/8 to 4/8 of cumulonimbus at 1,600 ft, air temperature 26°C, dew point 24°C, QNH 1009. Trend: tempo 340° 15 / 25 kt, visibility 4,000 m, moderate showers, 3/8 to 4/8 of cumulonimbus.

1.7.3.2 Wind measuring equipment

The control tower has analog wind indicators at the control positions and a SIGMA terminal which receives wind, atmospheric pressure and temperature information from the thresholds of runways 04 and 22 and at about mid-runway.

The SIGMA terminal gives:

- the direction and the average wind speeds over the previous two minutes,
- the maximum speed over the previous ten minutes,
- the instant sector direction variation over the previous ten minutes (upper and lower terminals read every half-second),
- the variation in the instant speed over the previous ten minutes (maximum and minimum speeds read every half-second).

The analog wind indicators give:

- the direction and the average speed over the previous two minutes,
- the maximum speed over the last ten minutes.

The wind direction and speed information given to the crew by the controllers came from the analog indicators.

In addition, the DC10's GFMS gives a computed wind indication every second.

1.7.3.3 Wind parameters recorded

The average strength and direction of the wind over the previous two minutes is recorded by the aerodrome's meteorological station.

Between 9 h 47 min and 9 h 56 min, the wind speed increased rapidly, reaching 5.8, 6.1, 6.2, 6.6, 13.5, 14.9, 14.9, 16.3, 16.3 and 16.3 m/s at threshold 04, with a significant variation in direction. Between 9 h 52 and 9 h 53 min, the wind direction was 330° at threshold 04 while it was 310° at the meteorological station and 120° at threshold 22.

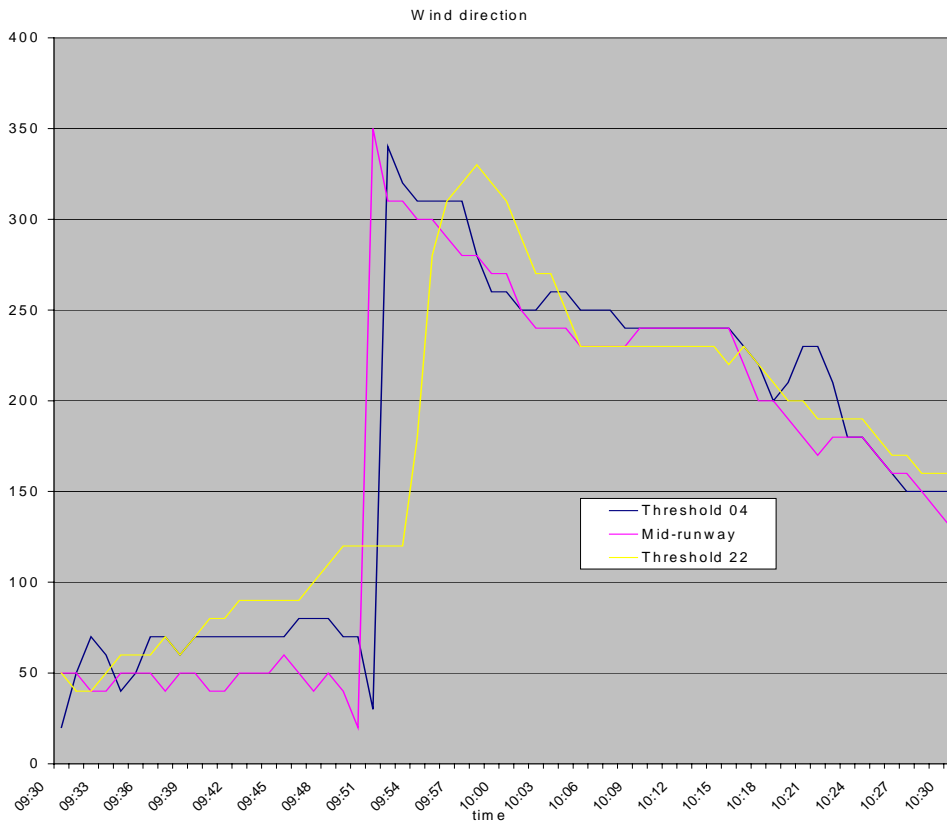
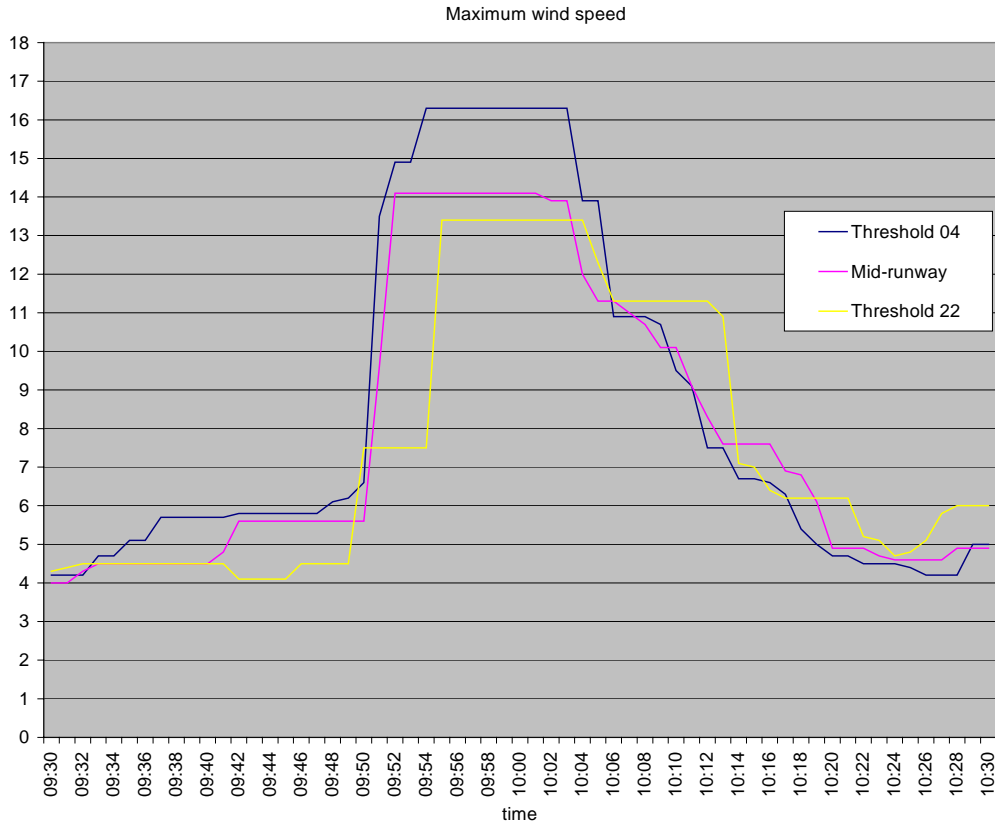

The variations in wind speed and direction indicate the presence of turbulent wind and windshear characteristic of a storm. The recordings also indicate that the stormy period lasted about fifteen minutes.

1.7.3.4 Rainfall

Between 9 h 45 min and 10 h 00, 4.2 millimeters of water fell during a shower. No showers had been observed during the previous two hours.

1.8 Aids to Navigation

The VOR-DME TAF, the ILS PT and the PAPI (see chart in appendix) used for the approach and landing were operating normally.

The final approach path is calibrated with a 5.24% slope arriving at a touchdown point compatible with displaced threshold 04, six hundred meters after the western end of the runway.

Note 1: The vertical clearance for a displaced threshold depends on the initiation point of the ILS glide path. It cannot be less than nine meters and must take into account the biggest airplane⁽²⁾ that regularly uses the runway. For Tahiti aerodrome, the airplane is the Boeing 747 and the clearance is set at 24.75 meters. The DC10 is in the same category as the B747 in terms of vertical distance D_{or} .

Note 2: The PAPI is a visual aid intended to give pilots an indication of the glide slope. It consists of a side bar made up of four groups of lights with clear separation between them. When the airplane is on the glide slope, the pilot sees two white lights and two red lights.

1.9 Telecommunications

The various frequencies used after HAL 481's entry into Tahiti airspace were recorded. The transcripts are appended to this report.

The first contact with the en-route control center took place at 7 h 48 min 21 s.

At 9 h 27 min 04 s, approach control contacted the crew, who were asking for meteorological information. The 9 h 00 METAR was given to them.

Contact with the tower took place at 9 h 42 min 40 s. Flight HAL 481's crew, who said they were established on the ILS axes, was cleared to land at 9 h 49 min 46 s and the wind was given to them: 060° at 10 kt, gusting to 14 kt.

At 9 h 51 min 24 s, new wind data was provided: gusting wind, 330° at 18 kt, gusting to 28 kt.

At 9 h 51 min 56 s, the crew had the field in sight and the final wind data was transmitted: 330° at 18 kt, gusting to 29 kt.

⁽²⁾ Related to the vertical distance between the pilot's eye and the airplane's wheels in approach configuration (D_{or}).

The crew's last message announced the runway excursion. Subsequently, some messages were transmitted by the crew (see appendix 1) and some by the tower (see appendix 5). They were not received and were thus not answered. It is likely that the damage caused by the runway excursion and the flooding of the hold interrupted the transmissions.

1.10 Aerodrome Information

Tahiti Faa'a aerodrome is a controlled aerodrome open to public air traffic. Its reference altitude is five feet, the same as for the threshold of runway 04. The magnetic orientation of runway 04 is 042°. The precision approach for runway 04 is category I.

For jumbo jets, the nearest diversion airport is at Rarotonga, which is 560 NM away.

1.10.1 Characteristics

The existence of a displaced threshold on runway 04 was made known to users by AIP / PAC amendment N°10 published in September 2000 that announced an effective in-service date of 5 October 2000. There was an error relating to the landing distance available (LDA) on runway 04 (3,310 m / 10,860 feet instead of 3,110 m / 10,203 feet) in update N°10. This error was corrected on 28 September 2000 by NOTAM and the chart documentation was updated by update N°12 published on 2 November 2000.

On 6 November 2000, the AIP documentation having been updated, the NOTAM was cancelled..

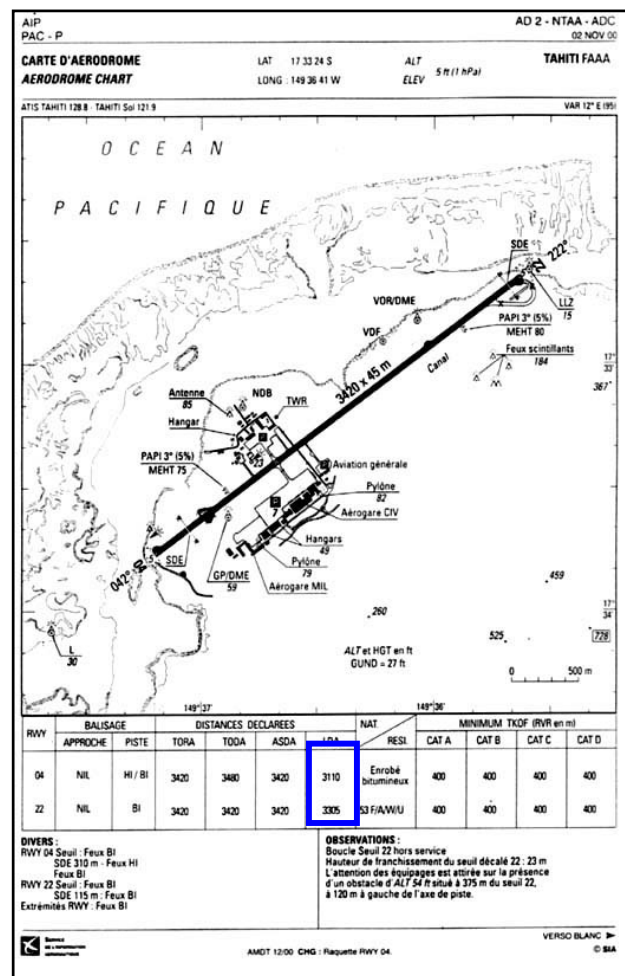

1.10.2 On-board documentation

The crew was using Jeppesen charts that did not take into account the various amendments published in September and November in the AIP/PAC.

On these charts, the displaced threshold did not appear and the LDA, 3,310 meters, did not take into account the displaced threshold. This distance was thus two hundred meters longer than the distance really available.

The Precision Approach Path Indicator (PAPI) was correctly calibrated and positioned at the displaced runway 04 threshold.

The Jeppesen “NOTAM chart” for 22 December 2000 did not mention any special points for the aerodrome.

Correction of the Jeppesen documentation was carried out after the event, at the suggestion of the operator.

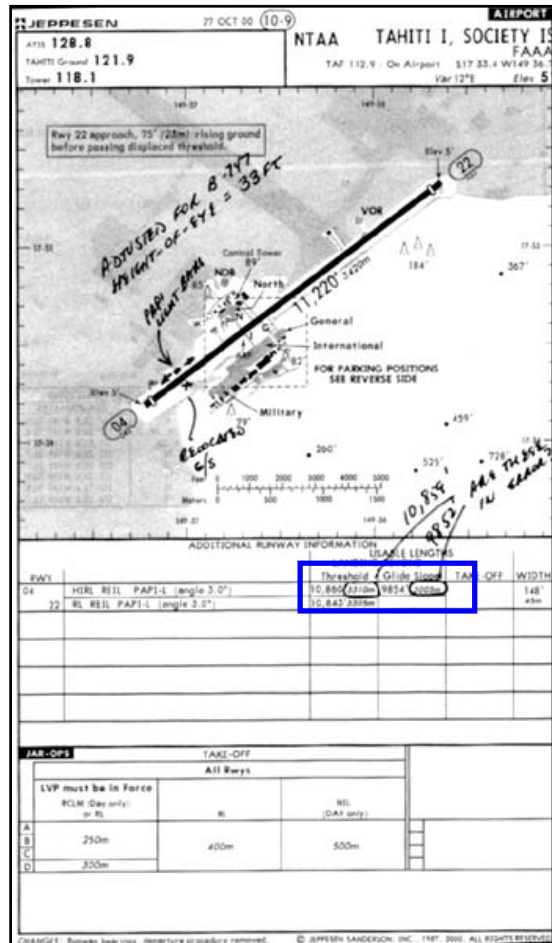

1.10.3 Runway lighting

At Tahiti Faaa, the runway threshold lights, the runway end lights and category I precision approach lights are in accordance with specifications of chapter 5.3 of Annex 14 (ICAO).

Note: Touchdown area lights are required only for runways that allow category II and III precision approaches.

Annex 14 recommends (paragraph 5.3.13.2) installing runway centerline lights on runways used for category I precision approaches, especially when the runway is used by airplane that have a high landing speed or where the spacing between runway edge lights is greater than fifty meters.

Note: this is only a recommended practice. Contrary to standards, States do not have to notify any variations in case of non-conformity.

This centerline lighting also allows the pilot to estimate his distance from the end of the runway through the color of the lights.

At the time of the accident, Tahiti Faaa aerodrome was not equipped with runway centerline lighting.

1.10.4 Runway surface condition

Annex 14 recommends that the friction characteristics of a runway should be periodically measured using self-watering continuous friction measuring equipment (§ 9.4.4 and supplement A § 7.5).

This information is not available at Faaa aerodrome, which has no measuring equipment.

Testimony from air crew that regularly use the aerodrome, and have had experience of it in rainy conditions, indicates that the runway's planimetry is not favorable for adequate water runoff during heavy showers. In addition, the flare height can sometimes be difficult to evaluate at night due to a layer of fog that forms through evaporation.

1.11 Flight Recorders

1.11.1 Types and readout operations

N132AA was equipped with a Flight Data Recorder (FDR) and a Cockpit Voice Recorder (CVR).

FDR

- Make: L3-COM
- Type: FA-2100
- Type number: 2100-4042-00
- Serial number: 00536

The recorder had a solid state memory with a recording time of at least twenty-five hours.

CVR

- Make: L3-COM
- Type: A100A
- Type number: 93-A100-80
- Serial number: 50223

The CVR had a magnetic tape with thirty minutes recording time. Both recorders arrived at the BEA on 8 January 2001. They were in good condition and readout could commence immediately.

1.11.2 FDR readout

Hawaiian Airlines did not possess any conversion documents allowing the raw binary data to be transformed into engineering values. American Airlines, the airplane's owner, provided two different conversion documents, not knowing which of the two corresponded to the airplane. After having selected the most likely document, the investigators met with conversion problems and validation of certain parameter values (Radio Altitude, acceleration and Glide Slope and Localizer deviations) had to be done based on recordings of previous flights. In addition, the operator was unable to provide up-to-date and exact documentation on the evolution of the parameter acquisition and recording system. Thus, the FDR readout was slowed down and some lack of precision may remain.

The graphs are in the appendices.

Of note, during final approach:

- The autopilot was disconnected at 9 h 52 min 10 s; the airplane was then at a radio altimeter height of 328 feet and its speed was 155 kt.
- Between autopilot disconnection and main gear touchdown, to the right of the runway centerline, the positions of the aileron and elevator controls changed rapidly, which indicates significant inputs on these controls.

Some parameters are shown in the following table for various phases of the landing.

	20 ft callout	10 ft callout	MLG touchdown	Nose gear touchdown	Spoiler extension	Lateral deviation	Runway excursion
Time	09:52:37	09:52:38	09:52:45	09:52:48	09:52:53	09:52:03	09:53:24
CAS (kt)	152	153	150	148	127	91	< 40
Heading	40°	39°	35°	36°	35°	44°	44°
Spoiler	Retracted	Retracted	Retracted	Retracted	Extended	Extended	Extended
Longitudinal acceleration (g)	0.11	0.11	0.05	-0.02	-0.14	-0.17	-0.15
	0.12	0.1	0.04	-0.04	-0.14	-0.16	-0.25
	0.12	0.1	0.04	-0.06	-0.12	-0.16	-0.3
	0.12	0.1	0.03	-0.06	-0.14	-0.17	-0.18
Lateral acceleration (g)	0.1	0.02	0.07	0.05	0.03	0.17	0.02
	0.03	0.03	0.01	0	0.01	0.15	0.08
	0.08	0.04	0.07	0.01	-0.01	0.21	0.01
	0.04	0.07	0.01	-0.01	-0.07	0.15	0.06
N1 engine	72	73	45	35	77	76	59
	66	66	41	35	73	66	48
	65	65	39	35	84	79	46
Thrust reversers	Retracted	Retracted	Retracted	Retracted	Deployed	Deployed	Retracted

1.11.3 CVR

The CVR transcript is in appendix.

The following points are of note:

- The landing briefing was carried out twenty-eight minutes before the landing. Despite the meteorological information received via the ACARS, which was identical to that which was provided by Faaa ATC one minute after the briefing, the crew did not mention the presence of cumulonimbus and the instability that dominated the area round the aerodrome. They planned to perform a VOR DME ILS approach to runway 04.
- During the descent, there were a lot of exchanges about the storm situation on the airplane's track and around the aerodrome. Twelve minutes before the landing, i.e. six minutes before the OVINI IAF, the crew mentioned the presence on the onboard meteorological radar of some thunderstorm cells.
- The spoilers were armed during the approach and the extension lever was activated seven seconds after main gear touchdown.
- A GPWS "Sink Rate" alarm was recorded on short final.
- The callouts of fifty feet down to ten feet occurred between 9 h 52 min 32 s and 9 h 52 min 38 s.
- The airplane went off the runway thirty-six seconds after main gear touchdown. The co-pilot asked for assistance on the Tower frequency while the Captain ordered the evacuation.

1.12 Wreckage and Impact Information

The left and right engines were resting on a sea wall made of rocks, eighty meters from the end of the runway. The airplane's nose was in the waters of the lagoon though the nose gear was not touching the bottom. The forward part of the fuselage and the electronics bay were in the water.

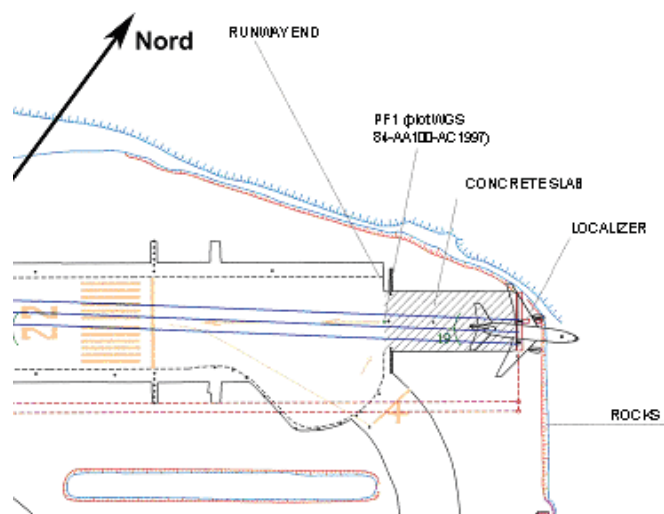

Source: Tahiti Faaa Air Transport Gendarmerie Brigade

The visible damage on the airplane, from forward to aft, was as follows:

- Impact marks between the nose and nose gear.
- The nose gear was marked by the impact with the localizer aerials, one of which was jammed inside. The anti-shimmy was destroyed. No serious structural damage was visible.
- The air intake on the right engine was punctured by a rock and that of the left engine showed signs of scraping along the ground. Some fan blades on the left engine were slightly damaged. The pylons of both on-wing engines were twisted.
- The left main landing gear had struck the localizer installations. Numerous contact marks with the antennae were visible.
- The left inner flap was damaged on its lower part. The right inner slat was deformed by contact with the pylon of engine three.

The day after the accident, the airplane was towed to the north ramp to be repaired.

Note: the localizer antennae, located seventy-two meters from the end of the runway, were destroyed.



1.13 Medical and Pathological Information

The investigation brought to light no evidence of any medical anomalies that may have altered the crew's abilities.

1.14 Fire

There was no fire.

1.15 Survival Aspects

Since the airplane was in landing phase, the cabin preparation had been carried out and the passengers and crew were seated and strapped in.

After the airplane stopped:

- The Captain and the Flight Engineer carried out the emergency evacuation procedure.
- The Chief Flight Attendant switched on the emergency evacuation lighting.

Given the sloping position of the airplane, the evacuation was carried out via the right center door emergency slide (2R) which was the only one considered to be usable. The slide at the left center door (2L) was also deployed but it seemed that the depth of the water was about fifteen meters. The lighting conditions made it difficult to evaluate the situation and advice was taken from the firefighters not to evacuate the passengers via that door. The end of the right slide was tied up to the sea wall located

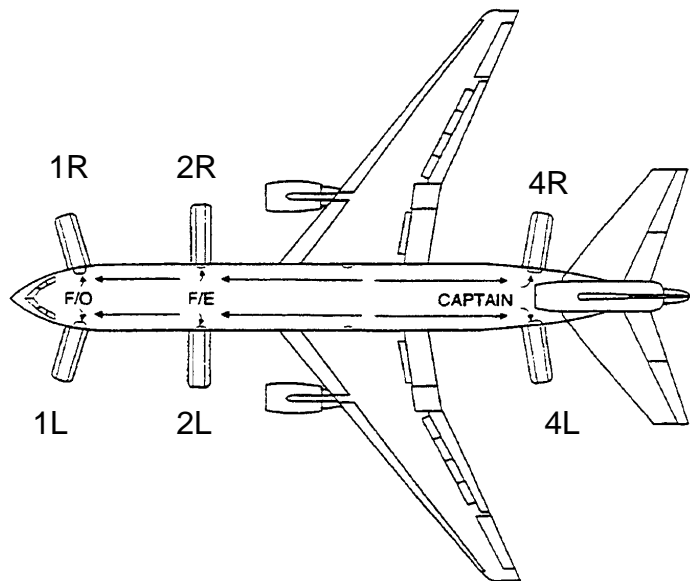

at the end of the runway so as to give the passengers the shortest walk possible through the water, which was shallow on that side. The passengers were greeted by the firefighters, who had taken care to remove the barbed wire coils that were protecting the aerodrome against intruders from that side.

On exiting the airplane, the safety of the passengers was ensured by the cabin crew who grouped them together on the runway while awaiting the arrival of transportation. All of the passengers were equipped with life jackets, but putting on the jackets had posed some problems (see 1.16.5). Some of the life jackets were found partially opened on the cabin floor.

Some of the passengers were French-speaking. Some of them stated that, in the course of the evacuation, they had some communication problems with the cabin crew who were speaking to them in English. The operator explained that for flights bound for Tahiti, some cabin crew members were selected according to their ability to speak French. Of the twelve cabin crew on the flight, two spoke French and translated the safety and evacuation announcements into French, though the loss of the PA system meant that it was impossible for them to be heard throughout the cabin.

1.16 Tests and Research

1.16.1 Airplane's track on the runway

The airplane's track on the runway was calculated from the accelerations, the localizer spacing and the airspeed recorded on the FDR, which allowed the main gear wheel touchdown position and time to be correlated.

The landing roll, compared with the airplane's magnetic heading, indicates that the airplane started sliding to the right for eleven seconds from touchdown of the main gear, then slid to the left, between 9 h 53 min and 9 h 53 min 13 s.

Ground track determined from recorded FDR data

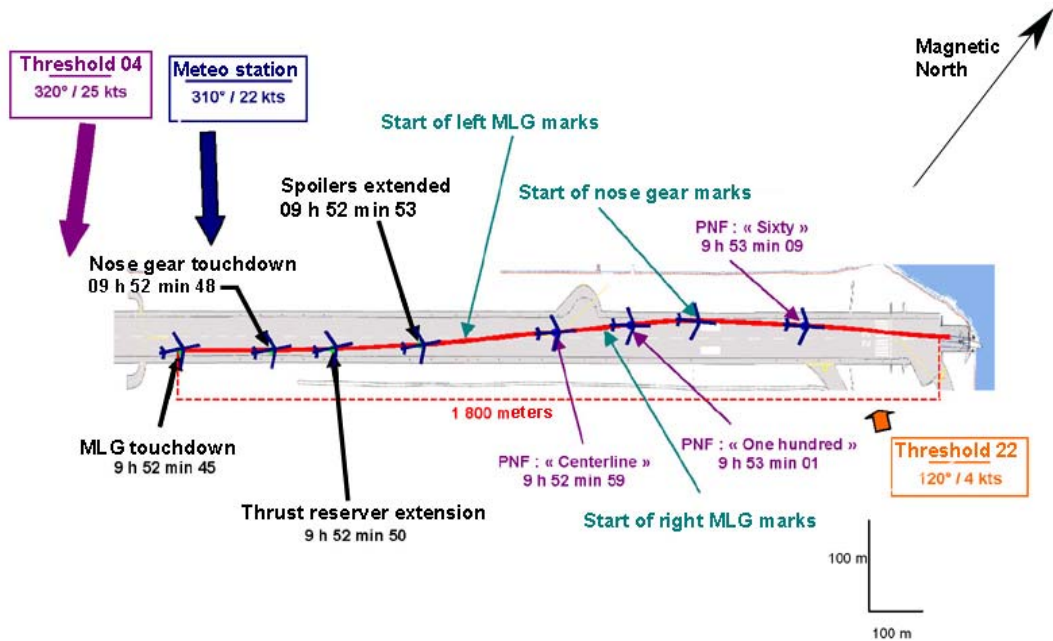

Note: The winds indicated above correspond to those at 9 h 53 min averaged over the last two minutes at thresholds 04 and 22 and the meteorological station. Threshold 04 is not included due to the scale chosen.

1.16.2 Wet runway and crosswind

On a wet runway and with a crosswind, the wind's effect on the fuselage and the tail tend to align the airplane into the face of the wind and to move across with the runway wind. This tendency of the airplane to align itself into the face of the wind and to be pushed off the centerline is increased by the application of reverse thrust.

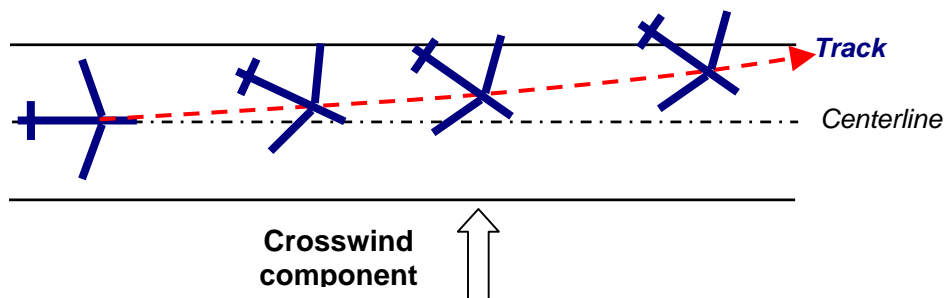

In addition, since adhesion is low on a wet runway, the effectiveness of braking is reduced. To limit this effect, a solid contact between the main gear wheels and the

runway through a firm landing allows the wheels to rotate more rapidly, thus reducing skidding. Setting the nose gear down quickly and a nose down movement on the control column also help to keep the airplane in good contact with the ground.

1.16.3 Examination of tires

A visual examination of the main gear tires was performed so as to determine the presence of any traces of possible local melting⁽³⁾ on the tires that would be characteristic of hydroplaning. No such traces were observed.

Note: These traces are not systematically present when an airplane slides on a wet runway. If, for example, the layer of water is thin and lubricates the runway, the tires can skid and there are no signs of vulcanization. This type of hydroplaning is denoted as viscous.

1.16.4 Spoilers

1.16.4.1 System description

By reducing lift on the wings, the spoilers push the airplane onto the ground and assist deceleration and improve braking.

In auto mode, their extension depends on the rotation speed of the main gear wheels. Under the following conditions, they cannot be extended:

- crosswind,
- wet runway,
- low vertical speed on touchdown.

During the landing roll, a roll input on the control column leads to the spoilers on the opposite wing to the input direction being retracted.

1.16.4.2 Use

The spoilers must be armed by the captain before landing. Spoiler arming is not checked during the landing checklist. The captain must ensure that they have extended after touchdown and extend them manually in case they do not extend automatically. The flight engineer must also check their extension and, if they do not extend when the thrust reversers deploy, he must extend them manually, which means he must lean forward.

1.16.4.3 Effect on landing distance

Without the spoilers, deceleration during the landing roll is not in accordance with performance as stated in the manufacturer's documentation. In case of a known unavailability of the system, an additional two hundred meters roll must be allowed

⁽³⁾ Airplane hydroplaning usually causes the water at the contact point to boil, which melts the rubber, leading to the obliteration of the tire tread.

for.

1.16.5 Examination of life jackets

The life jackets, manufactured by Hoover Industries, were packed by W. H. Brennan Inc. Some passengers had difficulties in using them. Some tests were performed on life jackets taken at random from the airplane and which had not been used during the evacuation.

On some of the life jackets, when the passenger put it on and pulled the “Pull to tighten” tag, the elastic band installed during packing to maintain the adjustment slack was placed in the male part of the attachment mechanism, thus preventing it from locking into the female part.

If the wearer managed to attach the male and female parts by forcing them, he could not pull the excess strap through the locking buckle and thus adjust the life jacket.

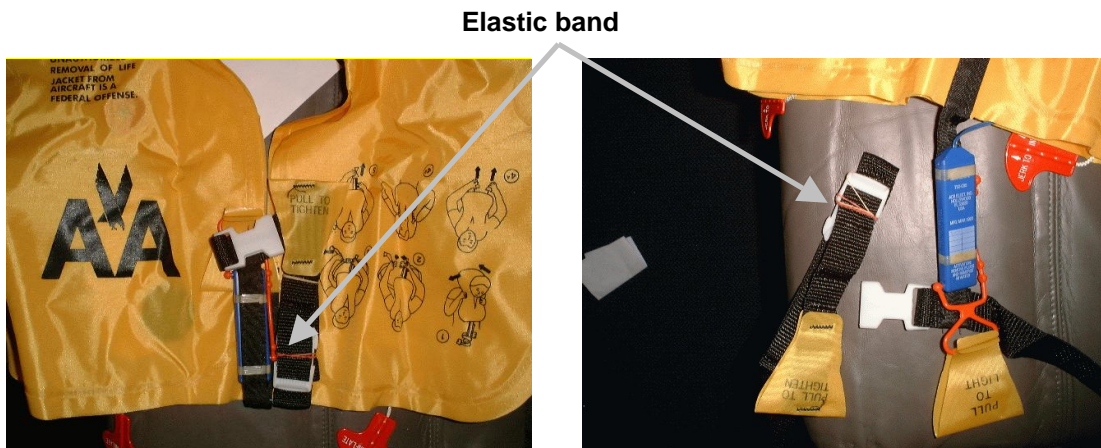

1.16.6 GFMS

The electronics bay, where the GFMS computers are located, was flooded with water during the runway excursion and the computers were damaged and rendered unusable. Further, it was impossible to read out their non-volatile memories so as to be able to get some parameters not recorded on the FDR, such as ground speed and wind.

1.17 Information on Organizations and Management

1.17.1 Flight preparation

Hawaiian Airlines' flight preparation is computerized and outsourced. The main parameters that had been determined for the landing were as follows:

Landing weight	336,024 lbs	Maximum landing weight	363,500 lbs
----------------	-------------	------------------------	-------------

Flaps	Vs	V _{ref}	Go-around N1
35°	109 kt	137 kt	98.2%

The approach speed, indicated by the flight engineer about twenty-five minutes before the landing based on the operations manual⁽⁴⁾, and equal to V_{ref}, plus half of the wind speed, plus a gust value, was 156 knots in the case of flight HAL481.

1.17.2 Crosswind procedure

The maximum value of the demonstrated crosswind component is thirty-one knots and does not constitute a flight manual limitation. On a wet runway, this value must be reduced to twenty knots.

Note: these values are based on an established wind speed.

1.17.3 Crosswind and wet runway procedure

If the airplane tends to deviate under the runway wind (see 1.16.2), the operations manual advises releasing pressure on the brakes and canceling use of the thrust reversers in order to regain directional control of the airplane. It states that an increase in thrust can allow the airplane to be re-aligned more easily, while calling attention to the limitations imposed by the length of the runway.

⁽⁴⁾ The Hawaiian Airlines operations manual is the same as that of American Airlines.

1.17.4 Use of flaps

The operations manual specifies:

- Use of the flaps at 35° when the runway is dry and longer than 7,000 feet,
- Use of the flaps at 50° in the following cases:
 - When the runway length is less than 7,000 feet,
 - When the runway is wet or slippery and when braking quality is lower than normal or in the case of a tail wind.

Note: The case of a wet runway with normal braking is not covered.

1.17.5 Crew training

Landing on a wet runway and hydroplaning are covered by Hawaiian Airlines during the pilots' line oriented flight training. They receive reminders on microbursts and wind shear during recurrent training courses.

Use of the flaps at 50° is dealt with during regular simulator training but the operator's common practice is to use them only at 35°. The operator justified this practice by citing the lower stresses on the airplane structure. However, the choice of the landing configuration remains at the Captain's discretion.

1.17.6 Calculation of landing and landing roll distances

Taking into account a flaps configuration of 35°, the graph relative to a landing at 335,000 lbs on a wet runway at sea level, with water level between three and six millimeters with full reverse thrust on all three engines, gives a required landing distance⁽⁵⁾ of 5,800 feet, so $LD_{35^\circ} = 1,740$ meters. The approach slope at Faa for QFU 04 is 5.24%. From a strictly performance perspective, by passing above the runway threshold by fifty feet, the corresponding computed distance between theoretical wheel touchdown and complete airplane stop is 1,450 meters⁽⁶⁾. The data drawn from the FDR showed that the distance between the touchdown and the runway excursion was about 1,800 meters.

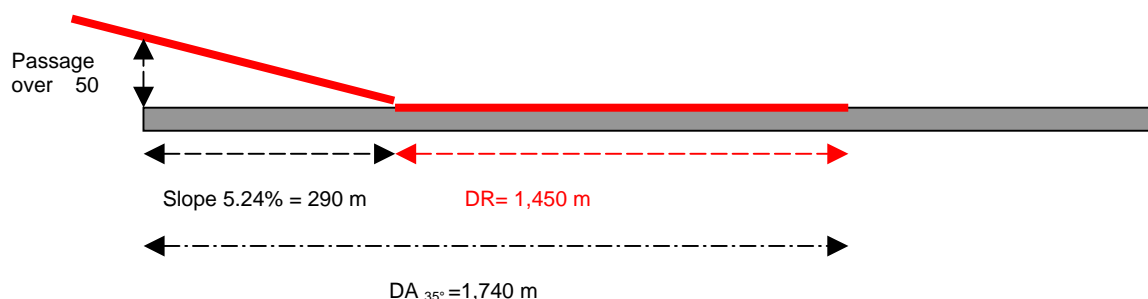

⁽⁵⁾ The landing distance (LD) is the distance between the passage over 50 ft and complete stop of the airplane.

⁽⁶⁾ The same calculation with a flaps 50° configuration gives 1,020 meters. It should, however, be noted that this configuration would likely have increased the airplane's glide distance and, perhaps, the wind effect.

It should be noted that the direction and strength of the wind, the runway slope, the temperature and the runway surface adhesion are also factors that influence the landing distance and that are not taken into account for this calculation.

1.18 Additional Information

1.18.1 Controller's testimony

The controller thought that the airplane was on the slope and the path with a significant drift. At the flare, he knew that the touchdown would be late since the crew had to correct the drift. At the moment the airplane passed abeam the tower, the controller thought that it was fast and had only a slight nose up attitude. He noticed that it touched down at about the level of the cross, after taxiway G. He heard the noise of the reversers a little after the touchdown and it seemed to him that this application of reverse thrust was done in a progressive manner.

The controller alerted the emergency services. He diverted an Air New Zealand plane to Rarotonga then, later the Air France flight to Los Angeles

1.18.2 Crew testimony

According to the crew, the landing gear lever was selected during the glide capture and the landing checklist was carried out shortly after. The spoilers were armed, the flaps extended to 35° configuration and the speed reduced to V_{ref} . The approach was carried out in clouds, without any particular turbulence. At six hundred feet, the crew saw the approach lights, the PAPI and the runway. It was raining and the windshield wipers were on.

The crew kept the autopilot on until about six hundred feet. Before landing, there was a "Sink Rate" alarm. The Captain then checked the PAPI indication and noticed that the airplane was a little low in relation to the glide slope. He corrected this and landed the airplane slightly to the right of the runway centerline. He selected reverse thrust and braked. He thought he recognized some hydroplaning. The Flight Engineer extended the spoilers manually after the "no spoiler" callout by the co-pilot.

The Captain wanted to bring the airplane back onto the runway centerline. The airplane was to the left of the centerline and the co-pilot called out "Centerline". The Captain then corrected to align the airplane on the centerline while continuing to brake and to use the thrust reversers. He thought that by using too much thrust reverser power he would have more difficulty in keeping the airplane on the runway.

The Captain did not see the distance indications on the runway, but, about three hundred meters from the end of the runway, he noticed a metal barrier across the end. He selected more thrust reverser power and increased pressure on the brakes. It seemed to him that he was on an ice-covered runway. The airplane hit the metal barrier and left the runway.

Fearing a fire, the Captain and the Flight Engineer carried out the evacuation procedure rapidly. The engines were shut down and the all the items in the procedure were carried out normally. The Captain used the PA to reassure the passengers.

The co-pilot informed the control tower then went into the passenger cabin to evaluate the situation in relation to the airplane's position. He decided not to use the aft doors for the evacuation, the airplane's tail being too high in relation to the ground. Doors 2R and 2L were open with slides deployed. He saw the water and the barbed wire and decided to wait for the Captain to arrive in the cabin before beginning the evacuation. The emergency services removed the barbed wire and attached a rope to the slide to bring it closer to the land. The evacuation took place calmly and very rapidly.

Captain's additional statement

The Captain stated that he had used reverse thrust because he wanted to control the airplane's direction in relation to the runway centerline. However, since page 10-4 of the Jeppesen document for Tahiti, noted as "Noise abatement Procedure", stipulated that reverse thrust should not be used between 5 h 00 and 16 h 00 UTC, except in case of emergency, he did not use it fully.

The airplane was not equipped with an automatic braking system. The Captain remembered that his action on the brakes seemed ineffective.

Flight Engineers additional statement

The Flight Engineer did not remember what distance the airplane had landed from the threshold. He remembered that there was neither any lighting indicating remaining runway length nor runway centerline lighting at Tahiti Faaa.

2 - ANALYSIS

2.1 Scenario

The Honolulu-Papeete flight encountered no particular problems until the initial approach.

2.1.1 The approach

During preparations for the landing, the crew did not take into account the presence of cumulonimbus around the aerodrome. During the descent, the extremely changeable meteorological conditions progressively made the crew more aware of the particular meteorological conditions on arrival. Nevertheless, they did not ask the controller how the situation had evolved over the aerodrome. Nor did they envisage delaying the landing, though a hold at OVINI was possible. Arriving on short final, they entered an area of rain and turbulence associated with the passage of a storm over the airfield at that moment.

2.1.2 The flare

The recordings of the intensity and direction of the wind along the runway show variations in all directions over time. The turbulent nature of the wind explains the Captain's significant inputs on the flight controls in order to maintain lateral control of the airplane's track, perhaps at the expense of control of the descent path on short final.

Thrust reduction was late: seven seconds passed between the radio altimeter "ten feet" call-out and touchdown of the main landing gear. This may be explained by the Captain's focusing on lateral control, and could be intentional, as a high thrust level allows for better control of the track. In any event, the high thrust led to an increase in glide distance. This increase was accentuated by a sudden headwind component, as is shown by an increase in computed airspeed four seconds before touchdown of the main landing gear.

The accumulation of these factors pushed back the touchdown zone by about nine hundred meters towards the middle of the runway.

2.1.3 The landing roll

On landing, the airplane veered to the left of the runway due to the crosswind, the wet runway and the use of the thrust reversers.

Although armed, the spoilers did not extend automatically after the wheels touched down. This phenomenon, linked to the main landing gear wheels starting to rotate, can occur during a landing in crosswind, on a wet runway or when the vertical contact speed with the ground is low. All of these conditions were present. The

Captain, absorbed by controlling the airplane's track on the runway, did not notice the non-extension. It was noticed by the flight engineer eight seconds after touchdown. During this time, the airplane was slipping and did not benefit from optimal aerodynamic braking; the effectiveness of the brakes was also reduced. This extended the airplane's ground roll.

Note: It is regrettable that the physical measurements of runway friction are not available, since this would make it possible to correct any deficiencies where necessary. In addition, they would also allow the pilot to select the most appropriate braking mode.

2.1.4 The runway excursion

When the Captain noticed the localizer antennae at the end of the runway, he increased inputs on the thrust reversers, now ineffective due to the airplane's speed, and on the brakes. These events occurred in the runway 22 touchdown area, an area whose surface is covered with tire rubber and where adherence is worse than on the rest of the runway. The airplane began to slide and the braking action was virtually nil, as the Captain indicated in his testimony. Nothing could then prevent a runway excursion.

2.1.5 The evacuation

The poor conditioning of some life jackets had no effect on safety since there were more life jackets than passengers and the evacuation of the airplane took place calmly and with no rush. It is probable that under other, less favorable, conditions, the discovery by the passengers of the unavailability of some life jackets could have been a factor leading to panic.

Although two of the cabin crew spoke French, some francophone passengers did not understand the safety instructions given during the emergency evacuation. This situation appears hard to avoid under emergency evacuation conditions, in particular where the public address system is inoperative, with the added stress and the obvious impossibility of grouping the passengers together according to their language. Under certain conditions, it may even be impossible to avoid this with passengers who speak the crew's language perfectly. Only attentive listening to the safety announcement presented at the beginning of the flight and the reading of the documentation available to each passenger can at least partially compensate for this difficulty.

2.2 Strategy for performing approaches

According to the regulations, an approach can only be initiated if the aerodrome is accessible, that is to say if the horizontal visibility is greater than the minimum value specified for the planned approach. The ceiling thus gives an indication of the chance of being able to perform the approach. Further, other parameters such as crosswinds, windshear and precipitation are taken into account by the crew. In

practice, these checks are performed during the briefing and the crew generally has a sufficiently precise idea at that time on how the approach will go up until the landing or, at least, until the minimum descent altitude (or height in the case of precision approaches).

In the case of the accident flight, the visibility conditions were clearly greater than the minima and the ceiling did not present any obstacle to a landing. The crew observed deterioration in the meteorological conditions during the approach, but this did not cause them to reassess the decisions that they had taken previously. Even the indications on the radar, which they qualified as "*serious*" did not stimulate any particular reaction on their part. A calling into question of the approach strategy decided on during the briefing was in fact difficult, since the performance of the approach left them little time available and the image of the approach had in part been fixed in the pilots' minds through the actions defined during the briefing.

Consideration of the changes in meteorological conditions announced by ATC, the weather radar information and the conditions observable outside could have prompted the crew to reconsider the approach strategy decided on during the briefing. Furthermore, the crew had to take into account the possible presence of windshear around the airfield, which could have made a go-around difficult once the final approach was started. Under these conditions, during the approach, the crew should have considered holding at OVINI so as to allow the stormy weather to pass over the aerodrome, especially since the diversion airfields for Tahiti Faa are a long way away.

Such a change in strategy during the approach is, however, unusual. It is likely that a crew would have recourse to this particularly when it has been mentioned during the preparation for the approach. This point could be emphasized during crew training so as to sensitize crews to the risks inherent in passing through a storm during landing. The probability of such simultaneous events is low and pilots almost never encounter them, which leads to an under-estimation of the risk.

2.3 Faa runway Infrastructure

Centerline lighting could have helped the pilot to determine the airplane's position, both laterally and in relation to the runway end.

2.4 Documentation used by the crew

Most operators use Jeppesen documentation and crews are used to doing so. However, although Jeppesen receives NOTAM's, the chart of the Tahiti airfield had not been updated. Such a failure could lead to dangerous situations for more restricted airfields, since it could lead to erroneous performance calculations during flight preparation.

Nevertheless, it should be noted that it is the responsibility of the operator to ensure that documentation used is up to specifications when it differs from the official documents.

2.5 Flight recorders

In contrast to the European JAR's, the American regulations do not oblige operators to perform a systematic flight analysis. This may help to explain the lack of follow-up in the management of conversion documents and in the maintenance of the parameter measurement and acquisition chain.

If it had not been possible to validate the parameters from previous flights, the parameters of the accident flight, although recorded on the FDR, might not have been usable.

3 - CONCLUSIONS

3.1 Findings

- The crew possessed the licenses and qualifications required to undertake the flight.
- The airplane possessed a valid Certificate of Airworthiness.
- The operator did not have the conversion documents for the recorded FDR parameters.
- The JEPPESEN aerodrome chart for Faaa did not take into account the modifications in runway landing distances notified by NOTAM.
- The possibility of a hold, given the evolution in the meteorological conditions, was not considered by the crew during the preparation of the approach.
- During the final approach, the airplane entered an area of rain and turbulence associated with the presence of a storm.
- The runway was wet, the wind was blowing from the left at the threshold of runway 04 and was between 18 and 28 knots.
- Due to the difficulties in controlling the airplane, thrust reduction was late.
- The touchdown of the main landing gear wheels occurred about one thousand three hundred meters after the displaced threshold of runway 04.
- Landing with a crosswind on the wet runway with a low vertical speed made it impossible for the spoilers to be deployed automatically.
- The flight engineer extended the spoilers manually eight seconds after touchdown of the main landing gear wheels.
- The airplane touched down to the right of the runway centerline, then its track veered to the left before coming back towards the center.
- The airplane left the runway along the extended centerline then came to a stop with its nose in the lagoon.

3.2 Causes of the accident

The accident was caused by the failure, during the preparation for the approach, to take into account the risk of a storm passing over the airfield at the time of landing.

The following factors contributed to the accident:

- The crew focusing on lateral control of the airplane's track, due to a strong crosswind that was changing in strength and direction, and late thrust reduction, resulting in a glide and a long touchdown;
- The late manual extension of the spoilers, which increased the length of the landing roll;
- The presence of water on the runway, the low vertical speed during contact with the ground and perhaps the slipperiness of the runway, which made the airplane slide, in particular in the threshold 22 wheel touchdown area.

4 - RECOMMENDATIONS

Performing an approach in meteorological conditions with local tropical storms over the aerodrome guarantees neither the landing nor a go-around. Once the decision is taken to perform the approach, however, it is difficult for a crew to reconsider, in this case as a result of deteriorating meteorological conditions, if they have not planned to do so when they develop their landing strategy during the arrival briefing.

Consequently the BEA recommends that:

- **operators ensure that crews are made aware of the importance of specifically planning, during the arrival briefing, for circumstances that would lead to a modification in the approach strategy, where the meteorological situation warrants it.**

The only information available concerning the characteristics of the runway at Tahiti Faa aerodrome is qualitative, which is inadequate for a precise evaluation of the influence of these characteristics on airplane braking.

Consequently the BEA recommends that:

- **the DGAC measure the adherence characteristics of the runway at Tahiti Faa aerodrome.**

The absence of runway centerline lighting could have contributed to increasing the crew's difficulties in positioning the airplane laterally and in relation to the far end of the runway.

Consequently the BEA recommends that:

- **the DGAC study the possibility of equipping all aerodromes on French territory used for public transport with runway centerline lighting.**

The regulatory documentation for French aerodromes is published by the French Aeronautical Information Service (IAC and AIP charts). Updates to this documentation can be the subject of NOTAM's. Crews, for their part, frequently use the Jeppesen documentation and erroneous information in the latter can have negative consequences in terms of safety.

Consequently the BEA recommends that:

- **operators systematically ensure that the documentation used by aircrew is in accordance with the relevant national regulatory documentation.**

Readout of the flight data recorder was complicated by and could have been jeopardized by the absence of conversion documents. Hawaiian Airlines did not possess these documents and those obtained from American Airlines, the owner of the airplane, contained errors. In France, operators are required to deposit these documents with the oversight authorities for airplanes included in the fleet list.

Consequently the BEA recommends that:

- **the FAA ensure that American operators possess up-to-date conversion tables for onboard data for airplanes used for public transport.**

List of appendices

APPENDIX 1
CVR transcript

APPENDIX 2
FDR graphs

APPENDIX 3
Recording of winds in the hour of the accident

APPENDIX 4
OVINI-VOR/DME-ILS approach chart for runway 04 on 2 November 2000

APPENDIX 5
Telecommunications transcript

CVR TRANSCRIPT

FOREWORD

The following is the transcript of the elements which were understood from the work on the CVR recording. This transcript contains conversations between crew members, radiotelephonic messages and various noises corresponding, for example, to the movement of selectors or to alarms.

The reader's attention is drawn to the fact that the recording and transcript of a CVR are only a partial reflection of events and of the atmosphere in a cockpit. Consequently, the utmost care is required in the interpretation of this document.

The voices of crew members are heard via the cockpit area microphone (CAM). They are placed in separate columns for reasons of clarity. Others columns are reserved for ; the voices of others, the noises and alarms also heard via the CAM ; VHF communications with ATC.

GLOSSARY

UTC	Timing synchronized with FDR and ATC communications from Tahiti-FAAA
CC	Cabin Crew
SV	Synthetic voice
→	Communications with ATC, the ground and the CC by interphone
?	Speaker not identified
(@)	Sound heard on the ATC channel
()	Word or group of words in parentheses are doubtful
(...)	Word or group of words with no bearing on the flight
(*)	Word or group of words not understood

UTC Time	Captain	First Officer	Flight Engineer	ATC center	Other voices, sounds, remarks
9 h 21 min 34	Beginning of recording				
9 h 23 min 34		→ Tahiti Tahiti Hawaiian Four Eight One position eight eight			
9 h 23 min 38				Hawaiian Four Eight One	
9 h 23 min 41		→ Tahiti Hawaiian Four Eight One check TAVAK zero niner two three flight level three seven zero next position TIAMA zero niner three niner Tahiti next that's our destination fuel remaining five six decimal one minus four seven wind one one five diagonal one two smooth go ahead			
9 h 24 min 09				Hawaiian Four Eight One report TIAMA one two six decimal seven	
9 h 24 min 14		→ TIAMA on one two six decimal seven Hawaiian Four Eight One			
9 h 24 min 35	Well guess we'll look at the um don't know what they're landing but I suspect it's gonna be four start down about a hundred and ten miles out or	Okay			

UTC Time	Captain	First Officer	Flight Engineer	ATC center	Other voices, sounds, remarks
	<p>ten miles out or so</p> <p>And uh let's see here uh depending on what we get cleared for that's five thousand on the arc until the two forty radial and then it's down to twenty five hundred and then into OVINI for the uh I L S uh V O R D M E I L S which is uh page eleven two twenty seven October zero zero the uh frequency is one oh nine nine zero four two and uh the V O R will have the D M E will be on your side</p>	<p>Okay</p>			
<p>9 h 25 min 41</p>	<p>And uh twenty five hundred until the uh seven point seven D M E intercept the glide slope down to a minimum of two fifty-five on the D A and uh radar uh at two-fifty</p>	<p>set</p>			
<p>9 h 25 min 59</p>	<p>Missed approach at the uh need a thousand meters on the R V R</p> <p>If it's that bad the miss is kind</p>	<p>right</p>			

UTC Time	Captain	First Officer	Flight Engineer	ATC center	Other voices, sounds, remarks
	of uh complicated here runway heading until the two mile D M E and then a left turn to three twenty intercept three sixty out to the eighteen mile arc and uh altitude to be assigned by control around to uh MOANA arc eighteen mile arc around and MOANA is the thirteen so its a come back in on the uh zero four two radial				
9 h 26 min 43	Anything to add?				
9 h 26 min 50	For some reason we have to go to the other side then we'll do uh the STAR to two two				
9 h 26 min 57		Okay			
9 h 26 min 58	Now I think that's just the V O R approach we'll dig that out real quick if we have to				
9 h 27 min 02		Okay			
9 h 27 min 03	Let's get a hold of em we'll get the weather				
9 h 27 min 04				Hawaiian Four Eight One on the freq?	
9 h 27 min 05	there he is				
9 h 27 min 07		→ Good			

UTC Time	Captain	First Officer	Flight Engineer	ATC center	Other voices, sounds, remarks
9 h 27 min 14		evening Hawaiian Four Eight One is coming up on TIAMA flight level three seven zero		Say estimate ARONA please	
9 h 27 min 18		→ Zero niner four zero			
9 h 27 min 32		→ And Hawaiian Four Eight One request weather			
9 h 27 min 38				Latest top nine o'clock zero eight zero degrees five knots visibility more than ten scattered one thousand five hundred scattered one thousand six hundred with Charlie Bravo broken five thousand temperature two six dew point two four Q N H one zero zero niner and temporary three four zero degrees one five knots gust two five knots visibility four thousand meters rain scattered one thousand Charlie Bravo overcast three thousand five hundred and	

UTC Time	Captain	First Officer	Flight Engineer	ATC center	Other voices, sounds, remarks
9 h 28 min 13		→ Hawaiian Four Eight One thank you		runway is wet	
9 h 28 min 16		It's the same one you got off the (*)			
9 h 28 min 18				And Hawaiian Four Eight One say your top of descent	
9 h 28 min 23		When do you want to start down			
9 h 28 min 25	Uh ARONA				
9 h 28 min 27		Want to start at ARONA?			
9 h 28 min 28	Yeah let's see outside ARONA and uh about another um forty miles thirty out of ARONA	okay			
9 h 28 min 38		→ We would like to start down thirty out of ARONA please Hawaiian Four Eight One			
9 h 28 min 44				Roger Hawaiian Four Eight One report for descent	
9 h 28 min 47		→ Four Eight One			
9 h 28 min 50	(*) (clearance)				
9 h 28 min 51		Okay			
9 h 28 min 56	We have the weather around there there's some (...) around there looks like				

UTC Time	Captain	First Officer	Flight Engineer	ATC center	Other voices, sounds, remarks
9 h 28 min 59		yeah			
9 h 29 min 10	(...)				Song
9 h 29 min 12	(*) got data				
9 h 29 min 14	(?) (got it)				
9 h 29 min 55	Good evening from the flight deck here we'll start our descent shortly into Tahiti and uh it's ten miles visibility rain showers in the area double check your seat belts fastened (*) rain showers (*)				
9 h 30 min 22	All right I'm done talking				
9 h 31 min 41	I guess you can request lower				
9 h 31 min 42		Okay			
9 h 31 min 45		→ Tahiti Hawaiian Four Eight One request descent			
9 h 31 min 50				Hawaiian Four Eight One confirm your radial of Tango Alpha Fox	
9 h 31 min 55	(?) Okay				
9 h 31 min 56		Confirm our what ?			
9 h 31 min 58		→ Say again for Hawaiian Four Eight One			
9 h 32 min 00				confirm your radial of Tango Alpha Fox	
9 h 32 min 04	Three forty	→ We			
9 h 32 min 05		→ We are at			

UTC Time	Captain	First Officer	Flight Engineer	ATC center	Other voices, sounds, remarks
9 h 32 min 11		three forty at eighty five miles now Hawaiian Four Eight One		Hawaiian Four Eight One descend to nine thousand feet and report passing ARONA	
9 h 32 min 19		→ Nine thousand feet report passing ARONA Hawaiian Four Eight One			
9 h 32 min 47	You might kinda watch that pack uh you don't know what that thing's gonna do				
9 h 32 min 52				Hawaiian Four Eight One ARONA first Victor arrival for D M E I L S zero four and say your estimate OVINI	
9 h 33 min 02		→ Stand by			(?) estimate
9 h 33 min 06	(*) drop that down there (*) OVINI (*) zero nine five zero				
9 h 33 min 18		→ Estimate OVINI for Hawaiian Four Eight One zero nine five zero	Ready for speeds		
9 h 33 min 28			Stow one Two nineteen One eighty nine Fifty six And thirty seven		

UTC Time	Captain	First Officer	Flight Engineer	ATC center	Other voices, sounds, remarks
9 h 37 min 23				(@)	V O R receiver "Tango Alpha Foxtrot"
9 h 38 min 54		→ Tahiti Hawaiian Four Eight One passed ARONA			
9 h 38 min 58				Hawaiian Four Eight One roger descend five thousand feet and uh report passing two four zero radial on the arcus one eight	
9 h 39 min 12		→ Okay down to five thousand feet report passing the two four zero radial Hawaiian Four Eight One			
9 h 39 min 23		Down five			
9 h 39 min 26	Down to five set and armed				
9 h 40 min 20			We're on the arc		
9 h 40 min 35	See weather out here on this corner I'm just gonna turn the ignition on I see lightning (*) I've got the radar on um see what it looks like under norm in normal it looks a little under map it looked real serious (*) I'm just doing that so I can kind a tell what the				

UTC Time	Captain	First Officer	Flight Engineer	ATC center	Other voices, sounds, remarks
9 h 40 min 58	difference is	Okay		Hawaiian Four Eight One contact me now on one one eight decimal one	
9 h 42 min 24					
9 h 42 min 29		→ Eighteen one Hawaiian Four Eight One			
9 h 42 min 32		Tahiti Hawaiian Four Eight One is with you on Eighteen one			
9 h 42 min 36				Okay Hawaiian Four Eight One report two four zero radial of Tango Alpha Fox	
9 h 42 min 42		→ Okay report the two four zero radial Hawaiian Four Eight One			
9 h 43 min 06	(...)				
9 h 44 min 52			→ Tahiti Hawaiian Four Eight One		
9 h 45 min 13		Two nine eight zero over here			
9 h 45 min 15	(*)				
9 h 45 min 19		Two nine eighty			
9 h 45 min 20	Nine eighty				
9 h 45 min 23		(*)			
9 h 45 min 27	Extend slats				
9 h 45 min 29		Slats			
9 h 45 min 31					Sound similar to slat lever activation
9 h 45 min 59			And flight		

UTC Time	Captain	First Officer	Flight Engineer	ATC center	Other voices, sounds, remarks
9 h 46 min 01	Bugs are set checked		instruments and Bugs		
9 h 46 min 02		Set checked right			
9 h 46 min 13		Coming up on two forty radial			
9 h 46 min 15	All right				
9 h 46 min 16		(*) twenty five			
9 h 46 min 25		→ Tahiti Hawaiian Four Eight One passing two four zero radial			
9 h 46 min 30				Hawaiian Four Eight One descend two thousand five hundred feet QNH one zero zero niner and report OVINI and euh... shower on the field	
9 h 46 min 40	Fifteen check				
9 h 46 min 42					Sound similar to flap lever activation
9 h 46 min 45		→ Okay will report OVINI down to two thousand five hundred Hawaiian Four Eight One			
9 h 46 min 49			→ Tahiti Hawaiian Four Eight One		
9 h 46 min 52		Over OVINI			
9 h 46 min 59	All right				
9 h 47 min 00	Forty two (*)				
9 h 47 min 10				(@)	Sound of Morse code P T

UTC Time	Captain	First Officer	Flight Engineer	ATC center	Other voices, sounds, remarks
9 h 47 min 13		Identified on your side			
9 h 47 min 22			→ Tahiti Hawaiian Four Eight One I UH no voice just modulation we will be on the ground in UH five minutes and no specials		
9 h 48 min 03	Ovini and (*)				
9 h 48 min 09	Okay				
9 h 48 min 13					Sound of landing gear warning horn
9 h 48 min 19		Thirty five for twenty five			
9 h 48 min 21	Thirty five for twenty five all right			Hawaiian Four Eight One cleared approach for D M E I L S zero four and report euh... loc and glide	Sound similar to cooling fan starting
9 h 48 min 31		→ Okay cleared I L S runway four report Loc and Glide Hawaiian Four Eight One			
9 h 48 min 37		→ And we just pass OVINI Hawaiian Four Eight One			
9 h 48 min 44	Gear down				
9 h 48 min 45		Gear down			Sound similar to gear lever actuation
9 h 48 min 56	Reach up there touch your windshield wiper in case you need it You know				

UTC Time	Captain	First Officer	Flight Engineer	ATC center	Other voices, sounds, remarks
9 h 49 min 00	where that is	yep			
9 h 49 min 02		Down three green			
9 h 49 min 04					Sound similar to spoilers being armed
9 h 49 min 05			Gear		
9 h 49 min 06		Down three green			
9 h 49 min 09	Twenty two on the flaps				
9 h 49 min 10					Sound similar to flap lever activation
9 h 49 min 12		Twenty two			
9 h 49 min 26	We'll use your D H light on the my radar one is KAPUTA				
9 h 49 min 34	(*)				
9 h 49 min 36	Thirty five flaps				
9 h 49 min 37		All right			
9 h 49 min 40					Sound similar to flap lever activation
9 h 49 min 41		→ Tahiti Hawaiian Four Eight One is established on localizer and glide slope			
9 h 49 min 46				Roger Hawaiian Four Eight One clear to land runway zero four zero six zero degrees ten knots gust one four knots	
9 h 49 min 53		→ Clear to land runway four Hawaiian Four Eight One			

UTC Time	Captain	First Officer	Flight Engineer	ATC center	Other voices, sounds, remarks
9 h 49 min 57		Cleared to land			
9 h 49 min 59	Cleared to land				
9 h 50 min 00		Roger			
9 h 50 min 02					Sound similar to stabilizer trim motor actuation
9 h 50 min 30	Quite a bit of crab in this thing				
9 h 50 min 33	A wind change in here (*) close in				
9 h 50 min 40		Two eighty at twenty eight right now			
9 h 50 min 41	Yeah				
9 h 50 min 43	Two eighty at what ?				
9 h 50 min 44		Twenty eight			
9 h 50 min 45	Twenty nine				
9 h 50 min 46	(*)				
9 h 50 min 55		(*) the I L S again?			
9 h 50 min 57	Oh Yeah				
9 h 50 min 59	Did you get it ? no ?				
9 h 51 min 00		No I' ve got it now			
9 h 51 min 02		That not...			
9 h 51 min 03	Oh you're on the V O R				
9 h 51 min 05		Now I change it			
9 h 51 min 06	Right				
9 h 51 min 07		Might be just uh thing acting up again			
9 h 51 min 10	Yeah				
9 h 51 min 17		Okay it's in back in anyways (...)			Laugh

UTC Time	Captain	First Officer	Flight Engineer	ATC center	Other voices, sounds, remarks
9 h 51 min 23		Okay			
9 h 51 min 24	Out of a thousand	Okay a thousand thirty five thirty five land cancel DH		Hawaiian Four Eight One gusty wind three three zero degrees one eight knots... one eight ... eight knots gust two eight knots report field in sight	
9 h 51 min 36		→ Hawaiian Four Eight One will report			
9 h 51 min 39			Landing check-list complete		
9 h 51 min 42	Yeah clear to land				
9 h 51 min 42	I 'm gonna add on... out of a thousand				
9 h 51 min 48	Thirty five thirty five				
9 h 51 min 50		Cancel DH missed approach altitude set			
9 h 51 min 54					Sound similar to windshield wipers on
9 h 51 min 57		→ Hawaiian Four Eight One has field in sight			
9 h 52 min 00		Five hundred on speed down eight		Roger cleared to land runway zero four three three zero degrees one eight knots	
9 h 52 min 06		→ Cleared to land zero four Hawaiian Four Eight One			
9 h 52 min 06		(*)			

UTC Time	Captain	First Officer	Flight Engineer	ATC center	Other voices, sounds, remarks
9 h 52 min 09		Cleared to land buddy			
9 h 52 min 11	Yeah				
9 h 52 min 11				Gust two nine knots	
9 h 52 min 14		→ Roger			
9 h 52 min 15		A little gusty			
9 h 52 min 18		Okay three hundred two hundred			
9 h 52 min 20					(VS) sink rate
9 h 52 min 21	Oh Oh Watch me				
9 h 52 min 26		One hundred			
9 h 52 min 29	Gusting right here				
9 h 52 min 31		Fifty			
9 h 52 min 32					(VS) Fifty
9 h 52 min 34					(VS) Forty
9 h 52 min 35					(VS) Thirty
9 h 52 min 37					(VS) Twenty
9 h 52 min 38					(VS) Ten
9 h 52 min 43		(*) wind shear			
9 h 52 min 48					Sound of selector followed by sound of touchdown
9 h 52 min 50		One hundred forty knots			
9 h 52 min 52					Sound similar to manual spoiler deployment
9 h 52 min 56		One twenty			
9 h 52 min 59		Centerline			
9 h 53 min 01		One hundred			
9 h 53 min 03		Ninety			
9 h 53 min 05		Eighty			

UTC Time	Captain	First Officer	Flight Engineer	ATC center	Other voices, sounds, remarks
9 h 53 min 07		Seventy			
9 h 53 min 09		Sixty			
9 h 53 min 12	(...)				
9 h 53 min 14		Get on the brakes			
9 h 53 min 19		→ Hawaiian			
9 h 53 min 21		Four Eight One			First sound of excursion
9 h 53 min 24		is uh right on the end going off the runway going off the end of the runway			Loud sound
9 h 53 min 26		→ Send the equipment			
9 h 53 min 27		send the equipment Hawaiian Four Eight One			Stop of the aircraft (PNC) bend over
9 h 53 min 31		Okay how many souls we had?			
9 h 53 min 32			One five six		
9 h 53 min 33	(...)	→ Roll the equipment Hawaiian Four Eight One has hundred fifty six souls on board			
9 h 53 min 39	Emergency evacuation				
9 h 53 min 45	Let's evacuate this thing				
9 h 53 min 48	Oh (...)				
9 h 53 min 50		→ Ah tower Hawaiian Four Eight One you copy? Roll the equipment			
9 h 53 min 55					Evacuation warning
9 h 53 min 58			End of recording		

FDR graphs

N132AA

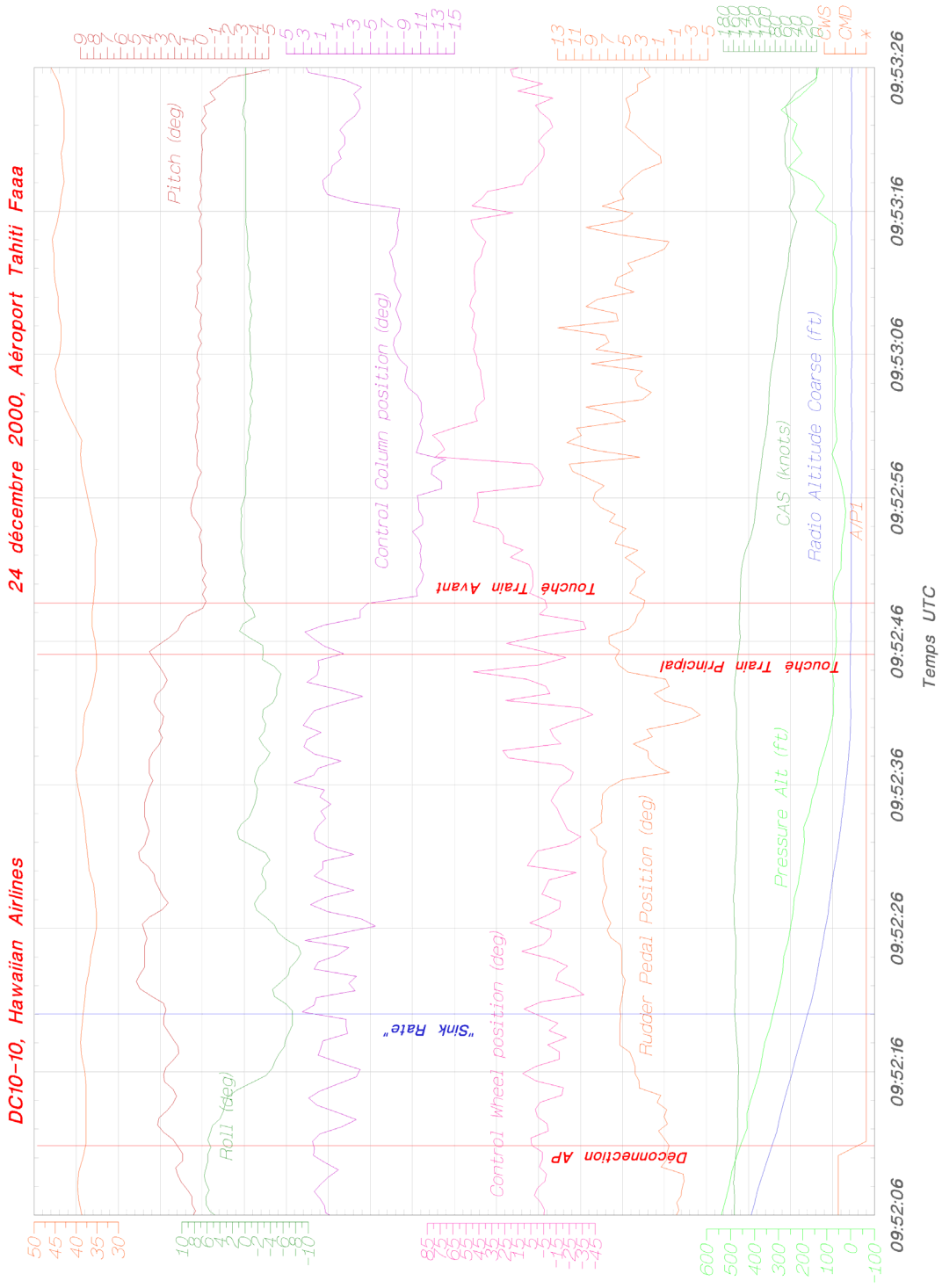

Created: April 02, 2003

BEA - Departement Technique

N132AA

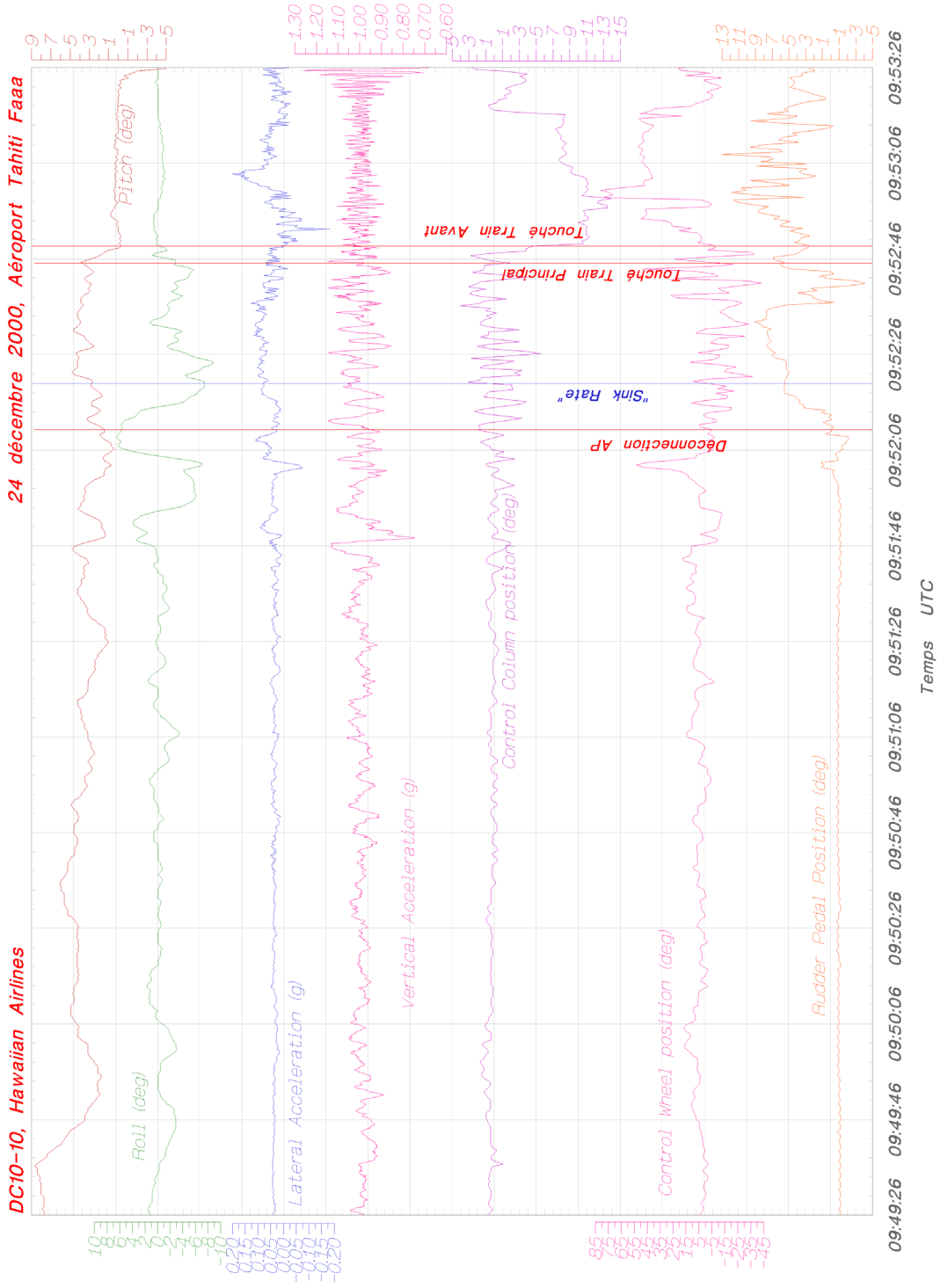

Created: November 22, 2002

BEA - Département Technique

N132AA

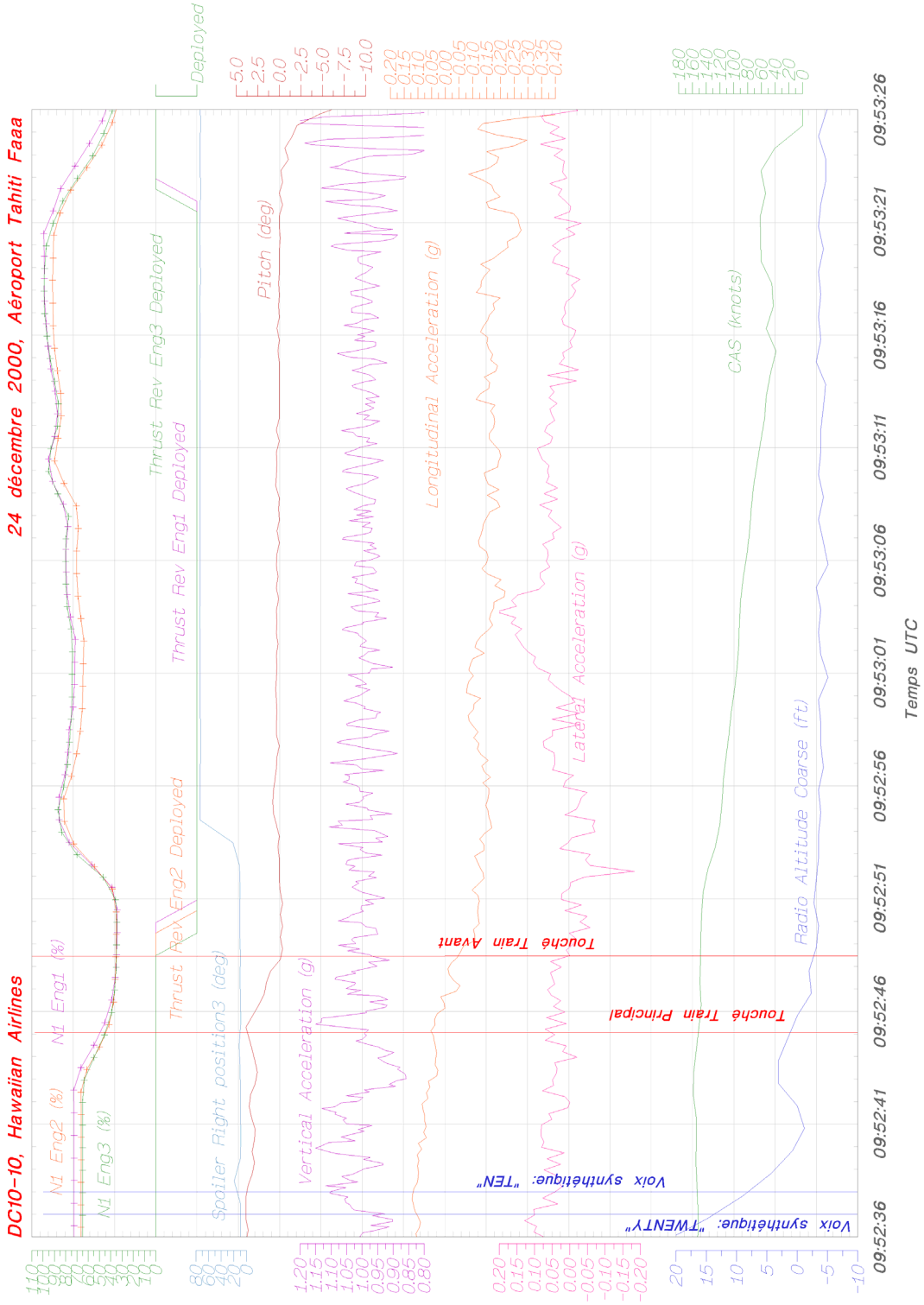

Created: June 05, 2002

BEA - Departement Technique

N132AA

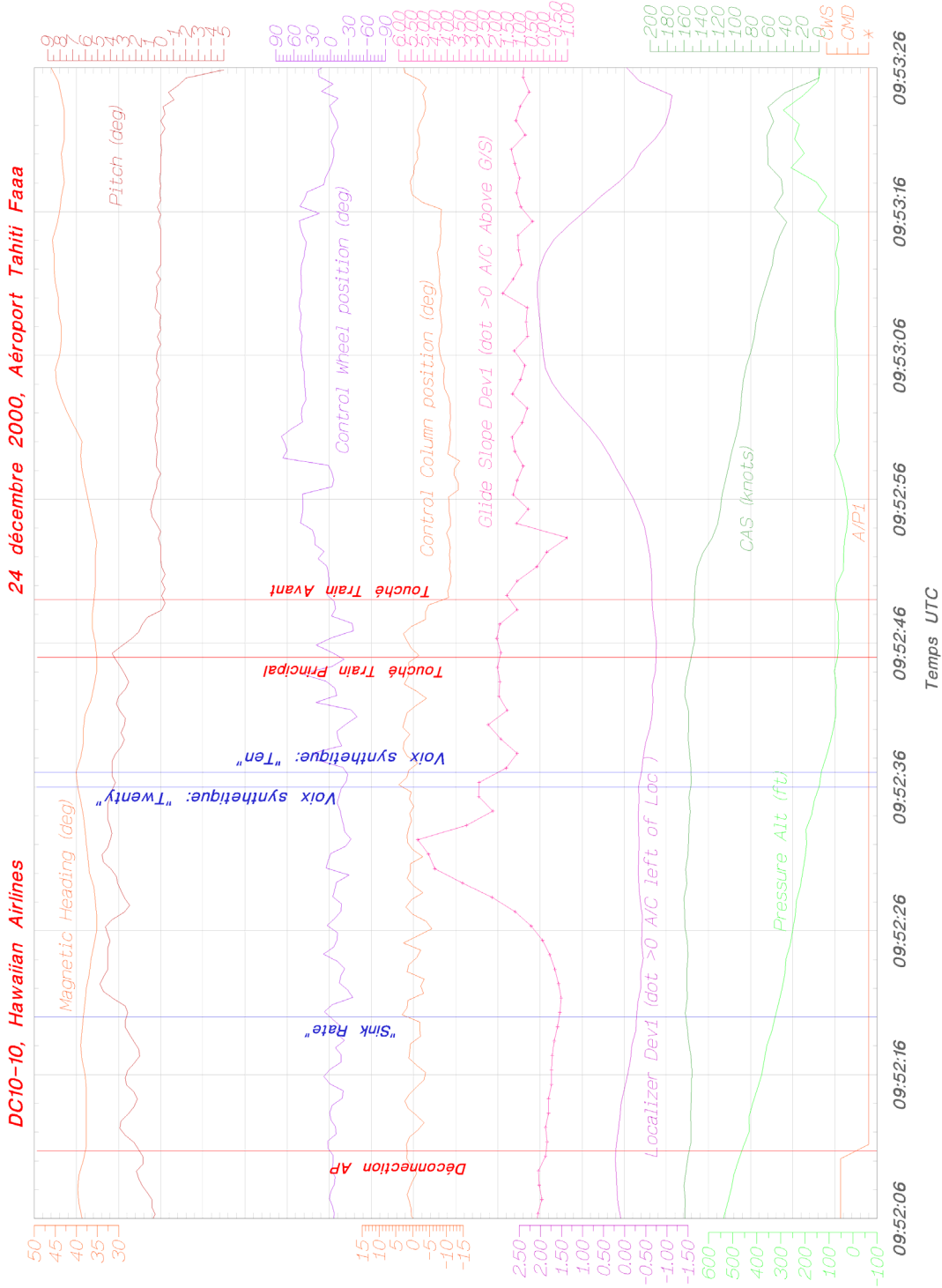

Donnees preliminaires
Created: March 31, 2003

BEA - Departement Technique

Recording of winds in the hour of the accident

dd/mm/yy hh:mm	Wind				Wind météo				Wind				thres hold	22					
	ff2	dd10	ff10	dmin	FMAX04	dd2	ff10	dmin	FMAXmétéo	ff2	dd10	ff10			dmin	FMAX22			
24/12/00 09:30	20	3,1	40	3	10	80	2	4,2	100	1,1	4	50	3	70	2,3	10	150	0,8	4,3
24/12/00 09:31	50	3,1	40	3,1	10	80	2	4,2	100	1,1	4	40	4	60	2,5	10	120	0,9	4,4
24/12/00 09:32	70	3,4	50	3,1	10	80	2	4,2	70	1,2	4,3	40	3	60	2,7	10	100	1,4	4,5
24/12/00 09:33	60	3,8	40	3,3	10	80	2	4,7	80	1,2	4,5	50	3	50	2,8	10	90	1,7	4,5
24/12/00 09:34	40	3,7	40	3,3	10	80	2	4,7	80	1,2	4,5	60	3	50	2,8	10	90	1,7	4,5
24/12/00 09:35	50	3,6	40	3,4	10	80	2	5,1	80	1,3	4,5	60	3	50	2,8	10	90	1,7	4,5
24/12/00 09:36	70	3,9	50	3,5	10	80	2	5,1	80	1,8	4,5	60	3	50	2,9	10	80	1,7	4,5
24/12/00 09:37	70	4,3	50	3,6	10	80	2	5,7	80	1,9	4,5	70	3	50	3	10	80	1,7	4,5
24/12/00 09:38	60	4,6	50	3,7	10	80	2,6	5,7	80	1,9	4,5	60	3	50	3	20	80	1,7	4,5
24/12/00 09:39	70	4,1	60	3,8	10	80	2,6	5,7	80	1,9	4,5	70	3	60	3	20	80	1,7	4,5
24/12/00 09:40	70	3,7	60	3,8	10	80	2,7	5,7	80	1,9	4,5	80	3	60	2,9	20	90	1,7	4,5
24/12/00 09:41	70	3,7	60	3,9	10	80	2,8	5,7	80	1,8	4,8	80	3	60	2,9	20	90	1,7	4,5
24/12/00 09:42	70	4,1	60	4	10	80	2,8	5,8	80	1,8	5,6	90	3	70	2,9	20	100	1,7	4,1
24/12/00 09:43	70	4,4	70	4	10	80	2,8	5,8	80	1,8	5,6	90	3	70	3	20	100	1,8	4,1
24/12/00 09:44	70	4,2	70	4,1	10	80	2,9	5,8	80	1,8	5,6	90	3	80	3,1	20	100	1,8	4,1
24/12/00 09:45	70	4,2	70	4,1	10	80	3	5,8	70	1,8	5,6	90	3	80	3,2	50	100	2,3	4,1
24/12/00 09:46	80	4,4	70	4,2	10	80	3	5,8	70	1,8	5,6	90	4	80	3,2	50	100	2,3	4,5
24/12/00 09:47	80	4,5	70	4,2	10	80	3	5,8	70	1,8	5,6	100	4	90	3,3	50	110	2,3	4,5
24/12/00 09:48	80	4,7	70	4,2	10	80	3	6,1	80	1,8	5,6	110	4	90	3,4	70	120	2,3	4,5
24/12/00 09:49	70	5,1	70	4,4	10	80	3	6,2	80	1	5,6	120	3	100	3,4	70	130	2,3	4,5
24/12/00 09:50	70	5	70	4,5	10	80	3,1	6,6	80	0,8	5,6	120	4	100	3,6	70	140	2,3	7,5
24/12/00 09:51	30	5,8	70	4,8	330	80	3	13,5	200	0,4	9,6	120	4	100	3,6	80	140	2,3	7,5
24/12/00 09:52	340	9,5	60	5,6	310	80	3	14,9	200	0,4	14,1	120	3	110	3,5	80	150	2,2	7,5
24/12/00 09:53	320	13	50	6,5	310	80	3	14,9	200	0,4	14,1	120	2	110	3,4	60	150	0,3	7,5
24/12/00 09:54	310	14	40	7,5	310	80	3	16,3	200	0,4	14,1	180	2	110	3,3	60	150	0,2	7,5
24/12/00 09:55	310	13	20	8,2	310	80	3	16,3	200	0,4	14,1	280	5	120	3,7	60	150	0,2	13,4
24/12/00 09:56	310	11	360	8,8	310	80	3	16,3	200	0,4	14,1	310	9	120	4,3	60	150	0,2	13,4
24/12/00 09:57	310	10	350	9,3	250	80	3	16,3	200	0,4	14,1	320	8	110	4,6	60	150	0,2	13,4
24/12/00 09:58	280	8,8	330	9,6	250	80	3	16,3	200	0,4	14,1	330	8	60	5	60	150	0,2	13,4
24/12/00 09:59	260	9,1	310	10	250	80	3	16,3	200	0,4	14,1	320	8	340	5,5	240	340	0,2	13,4
24/12/00 10:00	260	9,3	300	11	250	40	3	16,3	360	0,4	14,1	310	8	320	5,7	240	340	0,2	13,4

24/12/00 10:01	250	9	290	11	250	340	6,4	16,3	250	9,1	280	9,9	240	330	7,3	14,1	290	8	310	6,2	240	340	0,2	13,4
24/12/00 10:02	250	8,4	280	10	250	330	6,4	16,3	240	8,9	270	9,7	240	310	7,3	13,9	270	9	300	6,8	240	340	0,2	13,4
24/12/00 10:03	260	7	280	9,5	250	330	4,8	16,3	240	7,9	270	9,2	240	310	6,4	13,9	270	10	300	7,7	240	340	0,2	13,4
24/12/00 10:04	260	6,2	270	8,8	250	330	4,8	13,9	240	6,4	260	8,7	220	300	4,3	12	250	10	300	8,3	230	340	2,8	13,4
24/12/00 10:05	250	6	280	8,2	240	320	4,8	13,9	230	5,4	260	8,2	220	300	4,3	11,3	230	8	290	8,1	220	340	5,2	12,3
24/12/00 10:06	250	5,7	280	7,7	240	320	4,8	10,9	230	5,8	250	7,9	220	290	4,3	11,3	230	6	280	7,8	220	340	5,2	11,3
24/12/00 10:07	250	6	250	7,4	240	270	4,8	10,9	230	6,5	250	7,6	220	290	4,3	11	230	6	270	7,7	220	340	4,6	11,3
24/12/00 10:08	240	5,7	250	7	240	260	4,3	10,9	230	6,5	240	7,4	220	280	4,3	10,7	230	5	260	7,3	220	330	4	11,3
24/12/00 10:09	240	4,9	230	6,6	230	260	3,6	10,7	240	6,2	240	7	220	280	4,3	10,1	230	5	250	7,1	220	320	4	11,3
24/12/00 10:10	240	4,6	230	6,1	230	260	3,6	9,5	240	5,7	240	6,7	220	250	4,3	10,1	230	5	240	6,9	220	280	4	11,3
24/12/00 10:11	240	4,2	230	5,6	230	260	3,6	9,1	240	4,8	240	6,2	220	250	3,8	9,1	230	5	240	6,6	220	280	4	11,3
24/12/00 10:12	240	4	230	5,2	230	260	3,6	7,5	240	4,3	240	5,8	220	250	3,4	8,3	230	5	230	6,2	220	270	3,9	11,3
24/12/00 10:13	240	3,9	240	5	230	260	2,9	7,5	240	4,5	240	5,5	220	250	3,4	7,6	230	5	230	5,7	220	260	3,9	10,9
24/12/00 10:14	240	3,6	240	4,7	230	260	2,7	6,7	240	4,4	240	5,4	220	250	3,4	7,6	230	5	230	5,3	210	250	3,8	7,1
24/12/00 10:15	240	3,7	240	4,5	230	260	2,7	6,7	240	4	240	5,2	210	250	3,2	7,6	220	4	230	5	210	250	3,3	7
24/12/00 10:16	230	3,9	240	4,4	170	260	2,7	6,6	220	3,5	240	4,9	200	250	2,8	7,6	230	4	230	4,7	210	250	2,5	6,4
24/12/00 10:17	220	3,8	240	4,1	170	260	2,7	6,3	200	3,3	230	4,5	190	250	2,6	6,9	220	4	230	4,6	200	250	2,5	6,2
24/12/00 10:18	200	3,3	230	3,9	170	260	2,4	5,4	200	3,6	230	4,3	190	250	2,6	6,8	210	4	230	4,5	200	250	2,5	6,2
24/12/00 10:19	210	3,3	230	3,8	170	260	2,4	5	190	3,9	220	4,1	180	250	2,6	6,1	200	4	220	4,3	190	250	2,5	6,2
24/12/00 10:20	230	3,4	230	3,6	170	260	2,4	4,7	180	3,9	220	3,9	170	250	2,6	4,9	200	4	220	4,2	190	250	2,5	6,2
24/12/00 10:21	230	3,3	230	3,6	170	250	2,4	4,7	170	3,8	210	3,9	160	250	2,6	4,9	190	3	210	4	180	250	2,5	6,2
24/12/00 10:22	210	3	220	3,5	170	250	2,4	4,5	180	3,7	200	3,8	160	250	2,6	4,9	190	4	210	3,9	180	240	2,5	5,2
24/12/00 10:23	180	3	220	3,4	170	250	2,4	4,5	180	3,7	200	3,7	160	250	2,6	4,7	190	4	210	3,7	180	240	2,5	5,1
24/12/00 10:24	180	3,1	210	3,3	170	240	2,4	4,5	180	3,5	190	3,6	160	240	2,6	4,6	190	3	200	3,6	170	230	2,3	4,7
24/12/00 10:25	170	2,8	200	3,2	150	240	2,4	4,4	170	3,4	190	3,6	150	220	2,6	4,6	180	4	200	3,6	160	230	2,3	4,8
24/12/00 10:26	160	2,8	200	3,1	140	240	2,3	4,2	160	3,4	180	3,6	150	210	2,6	4,6	170	4	190	3,6	150	230	2,3	5,1
24/12/00 10:27	150	2,9	190	3,1	140	240	2,3	4,2	160	3,5	180	3,6	140	200	2,4	4,6	170	5	190	3,8	150	210	2,3	5,8
24/12/00 10:28	150	3	180	3,1	140	240	2,3	4,2	150	3,7	170	3,6	140	200	2,4	4,9	160	5	180	3,9	140	210	2,3	6
24/12/00 10:29	150	3,8	180	3,2	140	240	2,3	5	140	3,9	170	3,6	130	200	2,4	4,9	160	5	180	3,9	140	210	2,3	6
24/12/00 10:30	150	4,1	170	3,2	140	240	2,3	5	130	3,9	160	3,6	120	200	2,4	4,9	160	4	170	3,9	140	200	2,3	6

OVINI-VOR/DME-ILS approach chart for runway 04 on 2 November 2000

AIP
PAC - P

AD 2 - NTAA - IAC 1
02 NOV 00

APPROCHE AUX INSTRUMENTS INSTRUMENT APPROACH CAT A B C D

TAHITI FAAA
OVINI - VOR/DME - ILS RWY 04

ALTA0 : 5, SDE : 5 (1 hPa)

ATIS TAHITI : 128.8
APP : TAHITI Approche 121.3
TWR : TAHITI Tour 118.1
SOL : TAHITI Sol 121.9

ILS/DME	VAR
PT 109.9	12° E
RDH 50	(95)

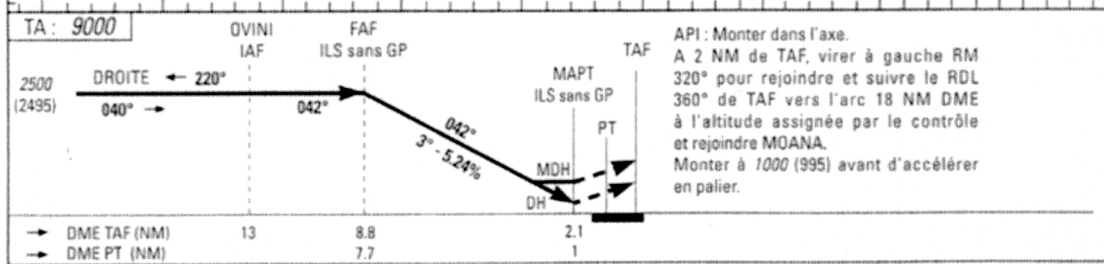
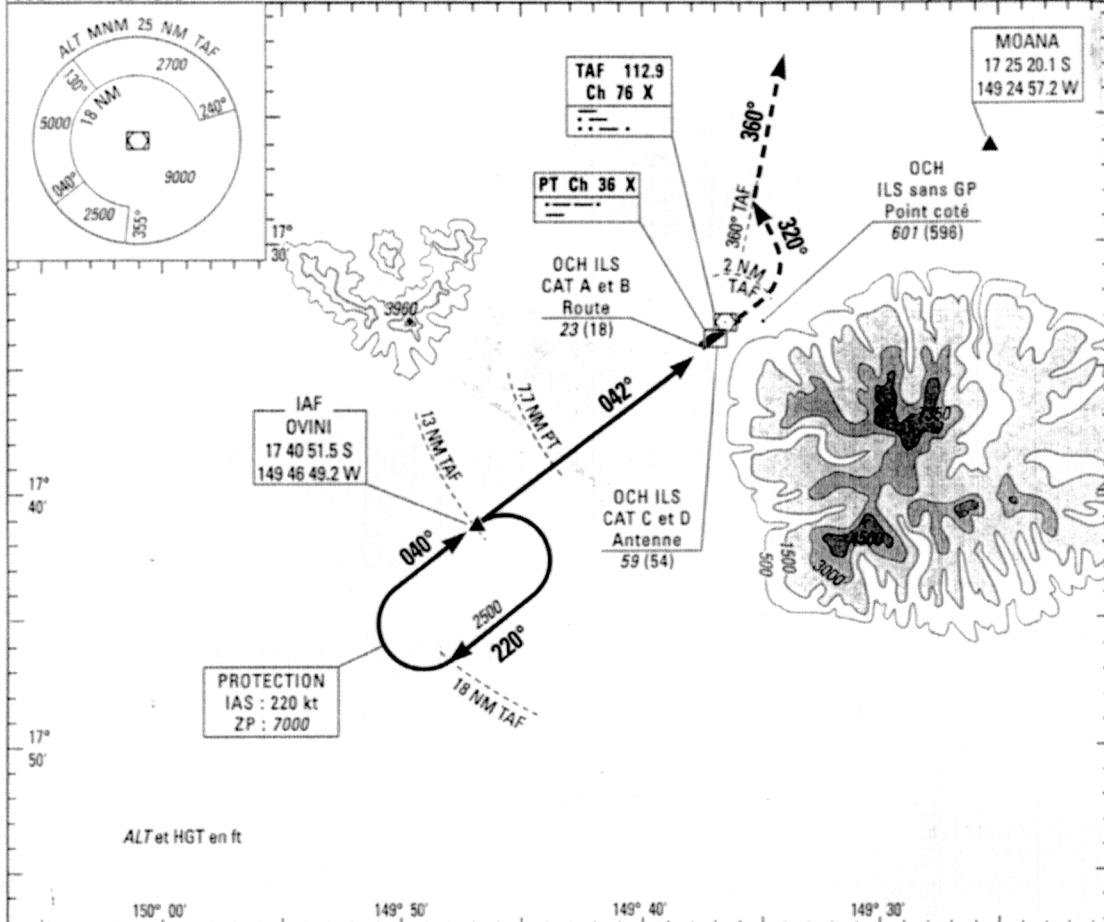

MNM AD : distances verticales en pieds, RVR en mètres. REF HGT : ALT SDE

CAT	ILS		ILS sans GP OCH : 401		OCH ILS	DME PT							
	DA (H)	RVR	MDA (H)	RVR		NM	7	6	5	4	3	2	1
A	280 (250)	1000	420 (410)	1500	A : 153	ALT	2280	1950	1620	1290	970	650	330
B				1500	B : 182	HGT	(2275)	(1945)	(1615)	(1285)	(965)	(645)	(325)
C				1800	C : 200								
D				2000	D : 200								

Observations : NIL

FAP - SDE	7.5 NM	70 kt 6 min 25	85 kt 5 min 17	100 kt 4 min 30	115 kt 3 min 55	130 kt 3 min 28	160 kt 2 min 49	185 kt 2 min 26
-----------	--------	-------------------	-------------------	--------------------	--------------------	--------------------	--------------------	--------------------



AMDT 12/00 CHG : Hauteur hippodrome, angle de descente.

© SIA

Telecommunications transcript

DE	HEURE	COMMUNICATIONS
Approche	9 h 27 min 04	Hawaiian 4 8 1 on the freq ?
HAL 481	9 h 27 min 07	Good evening Hawaiian 4 8 1 is coming up at TIAMA flight level 2 7 0
Approche	9 h 27 min 14	Say estimate ARONA please
HAL 481	9 h 27 min 18	0 9 4 0
HAL 481	9 h 27 min 32	And Hawaiian 4 8 1 request weather
Approche	9 h 27 min 38	Latest top 9 o'clock 0 8 0 degrees 5 knots visibility more than 10 scattered 1500 scattered 1600 with Charlie Bravo broken 5000 temperature 2 6 degrees dew point 2 4 degrees Q N H 1 0 0 9 and temporary 3 4 0 degrees 1 5 knots gust 2 5 knots visibility 4000 meters rain scattered 1000 Charlie Bravo overcast 3500 and runway is wet
HAL 481	9 h 28 min 13	Hawaiian 4 8 1 thank you
Approche	9 h 28 min 18	And Hawaiian 4 8 1 say your top of descent
HAL 481	9 h 28 min 38	We would like to start down 30 out of ARONA please Hawaiian 4 8 1
Approche	9 h 28 min 44	Hawaiian 4 8 1 report for descend
HAL 481	9 h 28 min 47	4 8 1
HAL 481	9 h 31 min 45	Tahiti Hawaiian 4 8 1 request descend
Approche	9 h 31 min 50	Hawaiian 4 8 1 confirm your radial of Tango Alpha Fox
Approche	9 h 31 min 58	Say again for Hawaiian 4 8 1
Approche	9 h 32 min 00	confirm your radial of Tango Alpha Fox
HAL 481	9 h 32 min 05	We are at 3 40 85 miles now Hawaiian 4 8 1
Approche	9 h 32 min 11	Hawaiian 4 8 1 descend to 9000 feet and report passing ARONA
HAL 481	9 h 32 min 19	9000 feet report passing ARONA Hawaiian 4 8 1
Approche	9 h 32 min 52	Hawaiian 4 8 1 ARONA first Victor arrival for D M E I L S 0 4 and say your estimate OVINI
HAL 481	9 h 33 min 02	Stand by
HAL 481	9 h 33 min 18	Estimate OVINI for Hawaiian 4 8 1 0 9 5 0
HAL 481	9 h 38 min 54	Tahiti Hawaiian 4 8 1 passed ARONA
Approche	9 h 38 min 58	Hawaiian 4 8 1 roger descend 5000 feet and uh report passing 2 4 0 radial on the arcus 1 8
HAL 481	9 h 39 min 12	Okay down to 5000 feet report passing the 2 4 0 radial Hawaiian 4 8 1
Approche	9 h 42 min 25	Hawaiian 4 8 1 contact me now on 1 1 8 1
HAL 481	9 h 42 min 29	18 1 Hawaiian 4 8 1
HAL 481	9 h 42 min 32	Tahiti Hawaiian 481 is with you on eighteen one
Tour	9 h 42 min 36	Hawaiian 4 8 1 report 2 4 0 radial of Tango Alpha Fox
HAL	9 h 42 min 42	Okay report the 2 4 0 radial Hawaiian 4 8 1
HAL 481	9 h 46 min 25	Tahiti Hawaiian 4 8 1 passing 2 4 0 radial
Tour	9 h 46 min 30	Hawaiian 4 8 1 descend 2500 feet QNH 1 0 0 9 and report OVIN

		I and euh... shower n the field
HAL 481	9h 46 min 45	Okay will report OVINI down to 2500 Hawaiian 4 8 1
Tour	9 h 48 min 21	Hawaiian 4 8 1 cleared approach for D M E I L S 0 4 and report euh... loc and glide
HAL 481	9 h 48 min 31	Ok cleared ILS runway 0 4 report loc and glide Hawaiian 4 8 1
Tour	9 h 48 min 37	And we just pass OVINI Hawaiian 4 8 1
HAL 481	9 h 49 min 41	Tahiti Hawaiian 481 is established on localizer and glide slope
Tour	9 h 49 min 46	Roger Hawaiian 4 8 1 clear to land runway 0 4 0 6 0 degrees 10 knots gust 1 4 knots
HAL 481	9 h 49 min 53	Clear to land 4 Hawaiian 4 8 1
Tour	9 h 51 min 24	Hawaiian 4 8 1 gusty wind 3 3 0 degrees 1 8 euh... 1 8 ... 8 knots gust 2 8 knots report field in sight
HAL 481	9 h 51 min 36	Hawaiian 4 8 1 will report
HAL 481	9 h 51 min 57	Hawaiian 4 8 1 has field in sight
Tour	9 h 52 min 01	Roger cleared to land runway 0 4 3 3 0 degrees 1 8 knots
HAL 481	9 h 52 min 04	Cleared to land 0 4 Hawaiian 4 8 1
Tour	9 h 52 min 11	Gust 2 9 knots
HAL 481	9 h 52 min 13	Roger
HAL 481	9 h 53 min 19	Hawaiian 4 8 1 is uh right on the edge going off the runway ... going off the end of the runway
Tour	9 h 53 min 33	Hawaiian 4 8 1 confirm ?
Tour	9 h 53 min 41	Vulcain ?
Tour	9 h 53 min 50	Hawaiian 4 8 1 Tahiti ?
Tour	9 h 53 min 19	Hawaiian 4 8 1 Tahiti ?

BUREAU D'ENQUETES ET D'ANALYSES
POUR LA SECURITE DE L'AVIATION CIVILE
Aéroport du Bourget - Bâtiment 153
93352 Le Bourget Cedex
FRANCE
Tél. : +33 1 49 92 72 00
Fax : +33 1 49 92 72 03
com@bea-fr.org

www.bea.aero / www.bea-fr.org

